

AMBIVISION

digital portable B mode Ultrasound Scanner

AV-3618V

User Manual for Veterinary use

Version A0

AMBISEA *Technology Corp., Ltd*

AMBISEA User Manual	Document No.	AV-3618V
	Revision	A0
AV-3618V Digital Portable B mode ultrasound scanner	Effective Date	2008/02/21
	Page	3/68

Table of Content

1	INTRODUCTION.....	6
1.1	COPYRIGHT	6
1.2	STATEMENT	6
1.3	MANUFACTURER'S WARRANTY	6
1.4	SYSTEM LABELS DIAGRAM	8
1.5	CONTRAINDICATION OF THE USAGE.....	10
2	SUMMARY.....	11
2.1	CHARACTERS	11
2.2	RANGE OF APPLICATION	11
2.3	IMPLEMENT STANDARDS	11
3	SYSTEM INTRODUCTION.....	12
3.1	APPEARANCE	12
3.2	PANEL.....	12
3.3	TECHNICAL SPECIFICATIONS.....	13
3.4	BLOCK SCHEMATIC DIAGRAM.....	14
3.5	FUNDAMENTAL PRINCIPLE.....	14
3.6	EQUIPMENT CONFIGURATION	14
3.6.1	<i>Standard configuration pieces</i>	14
3.6.2	<i>Optional pieces</i>	15
4	INSTALLING THE EQUIPMENT	16
4.1	OPERATING ENVIRONMENTAL REQUIREMENTS	16
4.2	UNPACKING AND ACCEPTANCE INSPECTION	16
4.3	STARTING THE INSTALLATION	16
4.4	PROBE HOOK'S INSTALLATION (SELECTED MATING)	17
4.5	EQUIPOTENTIAL CONNECTION	18
5	KEYBOARD AND TRACKBALL OPERATION.....	20
5.1	SCREEN DISPLAY	20
5.2	OPERATING KEYBOARD.....	20
5.3	TRACK BALL	28
6	OPERATION PROCEDURES.....	29
6.1	GETTING STARTED	29
6.2	DIAGNOSIS	29
6.3	MENU OVERVIEW	29
6.4	MEASUREMENT	33

AMBISEA User Manual	Document No.	AV-3618V
	Revision	A0
AV-3618V Digital Portable B mode ultrasound scanner	Effective Date	2008/02/21
	Page	4/68
6.4.1	Distance measurement.....	33
6.4.2	Circumference and Area Measurement.....	34
6.4.3	Volume measurement.....	36
6.4.4	Cardiac rate measurement (only at B/M modes).....	37
6.5	SAVE AND SWITCH TO STORYBOARD VIEW MODE.....	38
6.5.1	Saving a image.....	38
6.5.2	View a saved image.....	38
6.5.3	Review storyboard mode.....	39
6.6	OBSTETRICAL CALCULATION.....	40
6.7	DIAGNOSTIC REPORT.....	46
6.8	IMAGE PROCESSING.....	47
6.9	IMAGE PRINT.....	48
6.10	IMAGE UPLOAD TO COMPUTER.....	49
6.11	SHUT DOWN THE EQUIPMENT.....	49
7	CHECK AND MAINTENANCE.....	50
7.1	DETECT.....	50
7.2	EFFECTIVE SERVICE LIFE.....	50
7.3	HOST MAINTENANCE.....	50
7.4	PROBE MAINTENANCE.....	50
7.5	CLEANSING.....	52
7.6	CORRECTLY USE THE PROBE.....	53
7.7	EQUIPMENT DETECTION AND CALIBRATION.....	53
8	TRANSPORTATION AND STORAGE.....	54
8.1	ENVIRONMENTAL REQUIREMENTS OF TRANSPORTATION AND STORAGE.....	54
8.2	TRANSPORTATION.....	54
8.3	STORAGE.....	54
9	SIMPLE MALFUNCTION EXAMINATION AND TROUBLESHOOTING.....	55
9.1	EXAMINATION.....	55
9.2	TROUBLESHOOTING.....	55
APPENDIX A LABELS DIAGRAM.....		56
1.	AV-3618V MAIN UNIT NAMEPLATE DIAGRAM.....	56
2.	AV-3618V DEVICE PROBE NAMEPLATE DIAGRAM.....	56
3.	AV-3618V DEVICE OPTIONAL PROBE NAMEPLATE DIAGRAM.....	56
4.	AV-3618V PACKING DIAGRAM.....	57
APPENDIX B ACOUSTIC OUTPUT PARAMETERS.....		58
TEST MODE: B-MODE	TRANSDUCER TYPE: C1-7/60R.....	58
TEST MODE: B/M-MODE	TRANSDUCER TYPE: C1-7/60R.....	59

AMBISEA User Manual	Document No.	AV-3618V
	Revision	A0
AV-3618V Digital Portable B mode ultrasound scanner	Effective Date	2008/02/21
	Page	5/68

TEST MODE: B-MODE	TRANSDUCER TYPE: C1-8/20R.....	60
TEST MODE: B/M-MODE	TRANSDUCER TYPE: C1-8/20R.....	61
TEST MODE: B/M-MODE	TRANSDUCER TYPE: EC1-2	62
TEST MODE: B/M-MODE	TRANSDUCER TYPE: EC1-2	63
TEST MODE: B-MODE	TRANSDUCER TYPE: L1-3.....	64
TEST MODE: B/M-MODE	TRANSDUCER TYPE: L1-3.....	65
APPENDIX C OBSTETRIC TABLE		66
GESTATIONAL TABLE 1: EQUINE.....		66
GESTATIONAL TABLE 2: BOVINE		67
GESTATIONAL TABLE 3: SHEEP.....		68

AMBISEA User Manual	Document No.	AV-3618V
	Revision	A0
AV-3618V Digital Portable B mode ultrasound scanner	Effective Date	2008/02/21
	Page	6/68

1 Introduction

1.1 Copyright

This publication, including pictures and illustrations, is property of AMBISEA Technology Corp., Ltd. This is under the protection of International Copyright Law.

1.2 Statement

Information in this document is not changed in annotated. The manufactory does not state nor observe any other warranty basing on this point, and definitely give up any implied warranty basing on any special purpose of selling or making benefit.

Without previous written permission from the manufacture, this document must not be photocopied, reproduced or translated into any other languages.

The manufacture preserves the right of revision on this document without notice.

Some pictures in this manual, which are schematic diagrams for indication only, may disaccord with the real object; therefore the real object should be regarded as the final.

1.3 Manufacturer's warranty

AMBISEA Technology Corp., Ltd assumes the responsibility for device security, reliability and performance only under the preconditions that the disassembly, assembly and maintenance of the device are all performed by its assigned professional and the device is used strictly in compliance with the operation manual.

AMBISEA Technology Corp., Ltd ensures a guarantee period within a year and a half since the delivery day and promises there is no problem with the new device within the warranty period, AMBISEA Technology Corp., Ltd will maintain the device and replace the parts of non-man-made damages free. But will not repair or replace the device that the surface is damaged.

This guarantee will only available for failures occurred, which the device is operated in compliance by using the operation manual. And the guaranteed device can only be used in the prescribed range given in the manual.

This guarantee excludes losses or damages caused by external reasons, such as thunder struck, earthquake, theft, unsuitable use or abuse and refitting the device.

AMBISEA Technology Corp., Ltd do not has responsible for the devices' damages, which caused by the arbitrary connection to the different devices.

AMBISEA Technology Corp., Ltd do not takes on the responsible for losses, damages or injuries caused by the delayed service requests.

When there is problem with the device (products), please contact AMBISEA Technology Corp., Ltd in the meantime explains the device model, serial number, date of purchase and the nature of problem.

Announcements

To ensure the operational safety and the long-term stable performance, please read this operation manual closely and understand the equipment functions, operation and maintenance information before operating the device, especially pay attention to the contents of "Warning", "Caution" and "Note".

Misoperation or inobservance of the instructions, which were given by the manufacturer or its agents, may

AMBISEA User Manual	Document No.	AV-3618V
	Revision	A0
AV-3618V Digital Portable B mode ultrasound scanner	Effective Date	2008/02/21
	Page	7/68

result in device damage or personal injury.

The following convention works through this manual to declaration the special emphasis of some information.









"Warning": displays the neglect of it will cause the severe personal injury, death or realized property loss.

"Caution": displays the neglect of it will cause slight personal injury or property damage.







"Note": to remind the user of the installation, operation or maintenance information. These information is very significant but without risk. Any warning against dangers shall not be contained in NOTE.

Icon description

Equipment icon description

-  Note! Refer to accompanying documents
-  Turn-on (general supply)
-  Disconnect (general supply)
-  Signal output
-  Equipotent
- IPX7** Watertight-proof
-  Risky voltage
-  USB port
-  RS-232 port
-  Recycling of the carton

Shipping package icon description

	Handle with Care
	Temperature extremes
	Upward
	Piling limit
	Keep dry
	Protect against heat

AMBISEA User Manual	Document No.	AV-3618V
	Revision	A0
AV-3618V Digital Portable B mode ultrasound scanner	Effective Date	2008/02/21
	Page	8/68

1.4 System labels diagram

Refer to Appendix A for device labels.

Common suggestion of the Equipment regulation

◆ In operation

1. Heat radiation holes are strictly prohibited to be covered.
2. After shutdown, do not switch on the device within 2 - 3 minutes.
3. In scanning, if any abnormal cases are found, stop the scanning immediately and shut down the device.
4. Patient is not allowed to touch any non-application parts.
5. Do not press the keyboard overexertion; otherwise the equipment will be damaged.

◆ After operation

1. Switch off the device.
2. Pull out the plug from the power supply socket instead of pulling the cable.
3. Cleaning the coupling gel on the probe with soft medical sterilized tampon.
4. Put the probe into its box.

Common safety information

System approach to the safety and reliability of the device are taken into consideration as a part of designing and producing process, because this will also affect the safety of the operators and patients.

The following safety precaution must be implemented:

1. The device shall be operated by qualified operating staff or under their instructions.
2. Do not reconfigure the parameters of the device without permission. If necessary, please ask for AMBISEA Technology Corp., Ltd or its authorized agent for helping.
3. The device has already been regulated into its optimal performance. Do not adjust any preset control or the switch unless operate access the instructions in the manual.
4. If there is fault, please shut down the device at once and contact with AMBISEA Technology Corp., Ltd or their authorized agents.
5. If the device is needed to connect with the other company electronic or mechanical devices, please consult AMBISEA Technology Corp., Ltd.

AMBISEA User Manual	Document No.	AV-3618V
	Revision	A0
AV-3618V Digital Portable B mode ultrasound scanner	Effective Date	2008/02/21
	Page	9/68

6. Operation, storage and transportation environment of the device

Environmental requirements under the normal operation:

- a) Environment temperature range: +5°C~+40°C
- b) Relative humidity range: ≤80%
- c) Atmosphere pressure range: 86KPa~106KPa

Environment requirements of the storage and transportation:

- a) Environment temperature range: - 40°C~+55°C
- b) Relative humidity range: 10%~100%
- c) Atmosphere pressure range: 50KPa~106KPa

7. Ultrasound might cause harm on human body, please avoid the long time radiation. Appendix B for information of sound output parameters.

8. Please use standard power cable as the input line of the network power supply for the adapter to reduce risk.

9. AMBISEA Technology Corp., Ltd shall not take any responsibility for any risk resulted from propelled / unauthorized re-fitment by the users.

10. The power supply plug is the standard three pins plug; its protective grounding pin (terminal) should be connected with the protective grounding line from the main power.

EMC statement

AV-3618V shall not affect the basic performance of radio service and other equipments and can work well in its stated electromagnetic environment.

Warning

When AV-3618V works in strong electromagnetic environment exceeding its statement, its image might be interfered and the diagnoses could be influenced. At this time, please stop operating until the EMC interference is removed.

Warning

AMBISEA User Manual	Document No.	AV-3618V
	Revision	A0
AV-3618V Digital Portable B mode ultrasound scanner	Effective Date	2008/02/21
	Page	10/68

When AV-3618V works at the state of overlapping or paralleling with other equipments, there might be unexpected EMC problems; If it must work close to other equipments, please observe carefully and check if some equipment is influenced by unexpected EM coupling.

Warning

Replacement of non-standard probe parts may cause unexpected EMC problem.

NOTE

Accessory equipment connected to the analog and digital interfaces must be certified according to the respective IEC standards (e.g. IEC 60950 for data processing equipment and IEC 60601-1-1 for medical equipment). Furthermore, all configurations shall comply with the valid version of the system standard IEC 60601-1-1. Everybody who connects additional equipment to the signal input or signal output part configures a medical system, and is therefore responsible that the system complies with the requirements of the valid version of the system standard IEC60601-1. IF in doubt, consult the technical service department or your local representative.

1.5 Contraindication of the usage

- ◆ *The equipment is not suitable for inspection on organs containing with gas such as lung, etc.*
- ◆ *It is recommended not to check the parts with wounded or acute inflammation to avoid the cross infection.*

Patient in the following situations are not allowed to be checked with vagina and rectum probes: inflammation of the vagina, such as trichomonas virginities, colpomycosis, venereal disease etc; The unmarried, deformity of vagina, menstrual period, postmenopausal vagina atrophy, person with difficulty carry on the vagina ultrasonic examination, colporrhagia, placenta previa patient, etc.

The following patient is prohibited to use the puncture

High blood pressure, coronary heart disease, disturbance of blood coagulation and the bleeding tendency patient

AMBISEA User Manual	Document No.	AV-3618V
	Revision	A0
AV-3618V Digital Portable B mode ultrasound scanner	Effective Date	2008/02/21
	Page	11/68

2 Summary

2.1 Characters

This equipment is high resolution linear/convex ultrasound scanning diagnostic equipment. It adopts micro-computer control and digital scan converter (DSC), digital beam-forming (DBF), real time dynamic aperture (RDA), real time dynamic receiving apodization, real time Dynamic receiving focusing (DRF), Digital frequency Scan (DFS), 8 segments TGC, frame correlation technologies to endue its image with clarity, stability and high resolution.

There are five display modes: B, B+B, B+M, M and 4B; And 256 gray scale.

The system can process real time image display, freeze, save, load, zoom, up and down flip, left and right flip, black and white flip, and capacity cine loop; Multi-level scanning depth, angle, dynamic range, acoustic power, frame correlation factor regulation and focus number, focal space, focus position, etc.

Date, clock display; name, sex, age, doctor and hospital annotation; Distance, circumference, area, volume and heart rate measurement; EDD Measurement for equine, bovine, sheep, dog and cat. It offers 12 body marks. And Multiple-choice probes for the clinic diagnosis demands.

PAL-D video output offers connection to external video image printer and large-screen display and other equipments. High speed USB port provides real time image transfer to the PC.

Touch function folding keyboard made by apheliotropic silica gel and the trackball provides immediate, convenient and flexible operation.

The equipment is jet molding enclosure and potable structure. The usage of non-industrial frequency transformer controls power supply, programmability parts and the surface mounting technology (SMT) make the whole unit highly integrated.

The equipment consists with the main unit and electronic convex array probe. Standard configuration is LV2-3/6.5MHz Rectal Linear probe. And C1-7/60R/3.5MHz convex array probe, L1-3/7.5Mhz high frequency linear array probe, C1-8/20R/5.0MHz micro convex probe, EC1-2/13R/6.5MHz Transvaginal and EL1-3/7.5MHz endo-rectal probe for options.

2.2 Range of application

Application in animals' diagnosis, such as horse, moo-cow, sheep, cat and dog, etc.

2.3 Implement Standards

The equipment is designed and manufactured rigidly according to GB10152-1997 《B Ultrasound Diagnosis Equipment》, GB9706.1—1995 《Medical Electrical Equipment Part I: Safety General Requirement》 and GB9706.9-1997 《Medical Electrical Equipment Special Safety Requirement for Medical B-ultrasound Diagnosis and Monitor Equipment》. The equipment is C class B-Ultrasound diagnosis equipment and its electricity shock prevention type is Class I B type.

The environment test requirements conform with requirements of climate environment test group II, mechanical environment test group II of GB/T-14710-93 《Medical Electrical Equipment Environment Requirements and Test Methods》.

3 System Introduction

3.1 Appearance

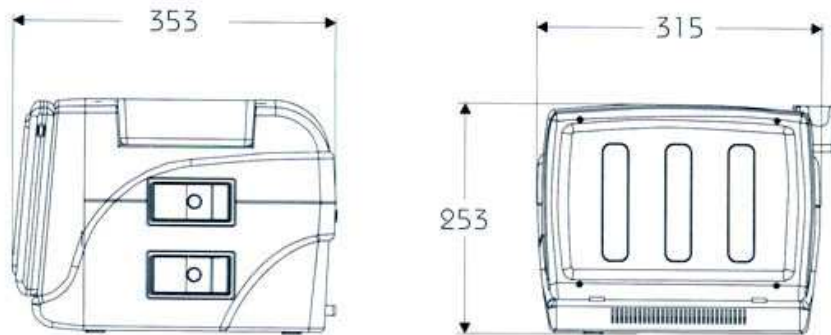

Figure 3-1 appearance's size sketch

3.2 Panel

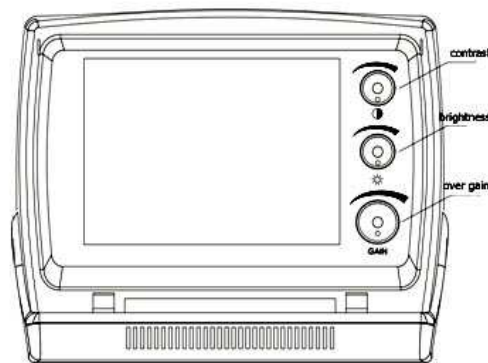

Figure 3-2. Front panel sketch

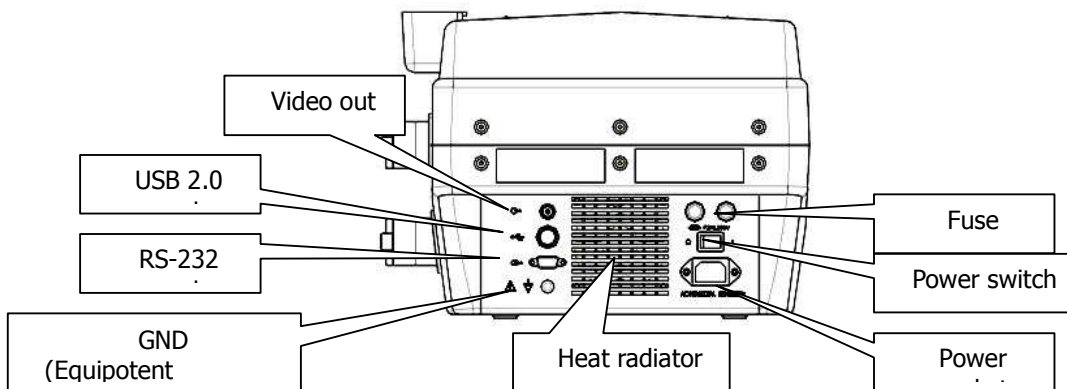



Figure 3-3. Back panel sketch

3.3 Technical specifications

MODEL		AV-3618V				
		Standard	Option			
Probe		LV2-3/6.5MHz Rectal Linear array probe	EL1-3/7.5 MHz Endo-Rectal probe L1-3/7.5MHz Linear probe	C1-8/20R/5.0 MHz Micro-convex probe	C1-7/60R/3.5 MHz convex array probe	EC1-2/13R/6.5MHz Transvaginal probe
Detect Depth(mm)		≥80	≥80	≥80	≥160	≥60
Resoluti on (mm)	Lateral	≤1 (Depth≤60)	≤1 (Depth≤60)	≤3 (Depth≤60)	≤2 (Depth≤80) ≤3 (80<Depth≤130)	≤1 (Depth≤40)
	Axial	≤1 (Depth≤80)	≤1 (Depth≤80)	≤1 (Depth≤60)	≤2 (Depth≤80) ≤3 (80<Depth≤130)	≤1 (Depth≤40)
Blind zone(mm)		≤3	≤3	≤8	≤5	≤7
Geometr ic position precision	Horizontal	≤5	≤5	≤15	≤15	≤10
	Vertical	≤5	≤5	≤10	≤10	≤5
Monitor size		10 inch				
Display mode		B、B+B、B+M、M、4B				
Image gray scale		256 level				
Cine loop		809 frames (MAX)				
Image storage		32 frames				
Scan angle		50%~100%				
Scan depth		40mm~240mm				
Acoustic power		2 steps				
Dynamic range		100dB~130dB				
Image flip		Up/down, left/right, black/ white				
Focus position		Adjustable				

	User Manual	Document No.	AV-3618V for vet
		Revision	A0
AV-3618V Digital Portable B mode ultrasound scanner		Effective Date	2008/02/21
		Page	14/68

Focal space	5 level
Measurement	Distance, circumference, area, volume, heart rate. GA, EDD
Notation	Date, time, name, sex, age, doctor、hospital name。 Full screen words edit.
output report	1 type
posture mark	12 types
USB port	High speed USB 2.0 (device)
power consumption (MAX)	100VA

3.4 Block Schematic Diagram

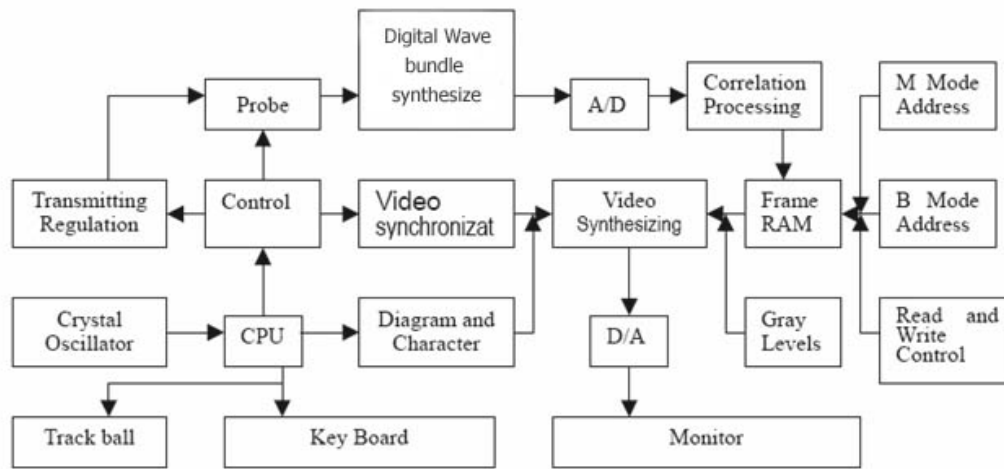

Figure 3-4 Electric principal block diagrams

3.5 Fundamental principle

Digital Ultrasonic Diagnostic System is based on the following procedure: different human organism possess different densities and speeds of transmission of ultrasound, i.e. different acoustic impedance (product of media density and sound speed).When piezo-chip (transducer) gets certainly regulated electric impulse, it will produce ultrasound with certain frequency. When this ultrasound (sound energy) is injected into human body, different organ surfaces will produce reflection echo, the different size reflection is received by the transduction which emitted ultrasound and is changed into electric impulse, when this electric impulse is amplified, demodulated, digital scanned, shifted and some other handling, video standard signal is produced and organ cross-Sectional images are displayed on the monitor.

3.6 Equipment configuration

3.6.1 Standard configuration pieces

- ◆ Mainframe
- ◆ LV2-3/6.5MHz Rectal Linear probe

AV-3618V Digital Portable B mode ultrasound scanner

- ◆ application software suite(CD)
- ◆ power cord
- ◆ High speed USB cable
- ◆ 2 pieces of fuse tube F2AL250V
- ◆ Coupling gel 250ml
- ◆ User Manual
- ◆ Final examination report
- ◆ Packing List

3.6.2 Optional pieces

- ◆ C1-7/60R/3.5MHz convex array probe
- ◆ C1-8/20R/5.0MHz micro convex probe
- ◆ L1-3/7.5MHz Linear probe
- ◆ EL1-3/7.5MHz endo-rectal probe
- ◆ EC1-2/13R/6.5MHz Transvaginal probe
- ◆ Video printer
- ◆ Trolley
- ◆ Abdomen probe puncture support
- ◆ Probe clasp

Warning

If select spare parts models prescribed above. The manufacturer will not assume the risks such as safety problem, non-expected drop of EMC performance that cause by arbitrary adoption of spare parts out of prescription.

	User Manual	
	Document No.	AV-3618V for vet
AV-3618V Digital Portable B mode ultrasound scanner	Revision	A0
	Effective Date	2008/02/21
	Page	16/68

4 Installing the Equipment

4.1 Operating environmental requirements

- a) Environment temperature range: +5°C ~ +40°C
- b) Relative humidity range: ≤80%
- c) Atmosphere pressure range: 86KPa ~ 106KPa
- d) Power supply: AC110V-10% ~ 130V+10%/220V-10% ~ 240V+10%, 50Hz/60Hz

Using the equipment, avoid strenuous vibration, keep it away from devices with high field, intense magnetic field or high voltage; avoid strong sunlight blazing down on the display; keep the device well-ventilated, moisture proof and dustproof.

4.2 Unpacking and Acceptance Inspection

After unpacking, please check the device according to the "packing List" and there has not been damage or had any fault during transportation. Install it following with the requirements and methods described in "Installation".

Warning

At acceptance inspection, if the equipment has been damaged, it must be forbidden to use for security reason.

Warning

The probe should be protected from falling off or crashing, and the manufacturer assumes no responsibility for this kind of hazard.

4.3 Starting the installation

1. Check the power supply to see if it is in the expected range, then connect the equipment and the power socket with the cable (see figure 3-3).
2. A 96-core connector is used for electronic convex array probe (see figure 4-1).
3. Connection of 96-core connector. First, switch the locker on the probe connector to "OPEN", position the connector localization pin with the hole on the socket, then plug in the connector and switch the locker to "LOCK". When the locker is moved to "OPEN", unplug the connector to remove the probe from the main unit. (see figure 4-2).

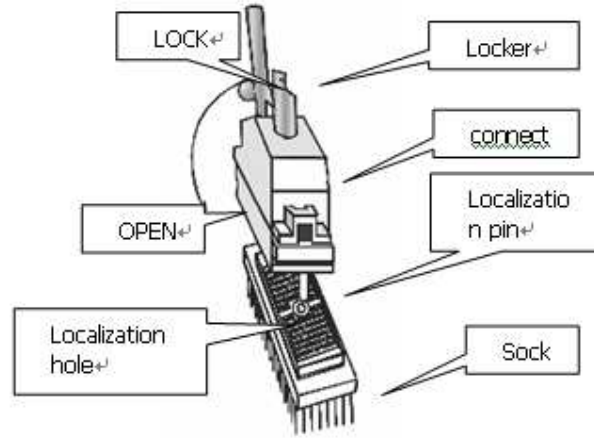

Figure 4-1 96-core probe connection sketch

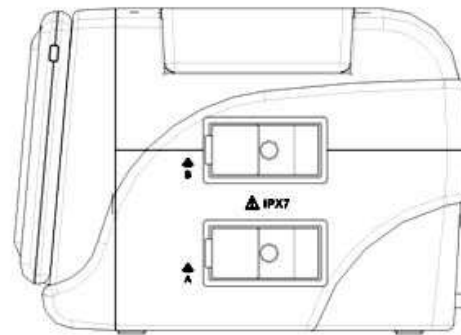

Figure 4-2. Probe socket sketch

Note

Avoid by all means unplugging or plugging the probe connector at state of log on in case the probe and main unit be damaged.

Once the probe is connected with the main unit, do not unplug nor plug it at discretion in case poor contact happen.

Warning

Must not touch the contact pin in the probe connector.

4.4 Probe hook's installation (selected mating)

Put the probe hook into the hook fixing seat, wind the nut up until the probe hook is fixed in the right position. See figure 4-3, 4-4:

AMBISEA	User Manual	Document No.	AV-3618V for vet
		Revision	A0
AV-3618V Digital Portable B mode ultrasound scanner		Effective Date	2008/02/21
		Page	18/68

Fix the probe hook nut



Figure 4-3 Installing the probe hook step 1



Figure 4-4 Installing the probe hook step 2

4.5 Equipotential connection

See the figure:

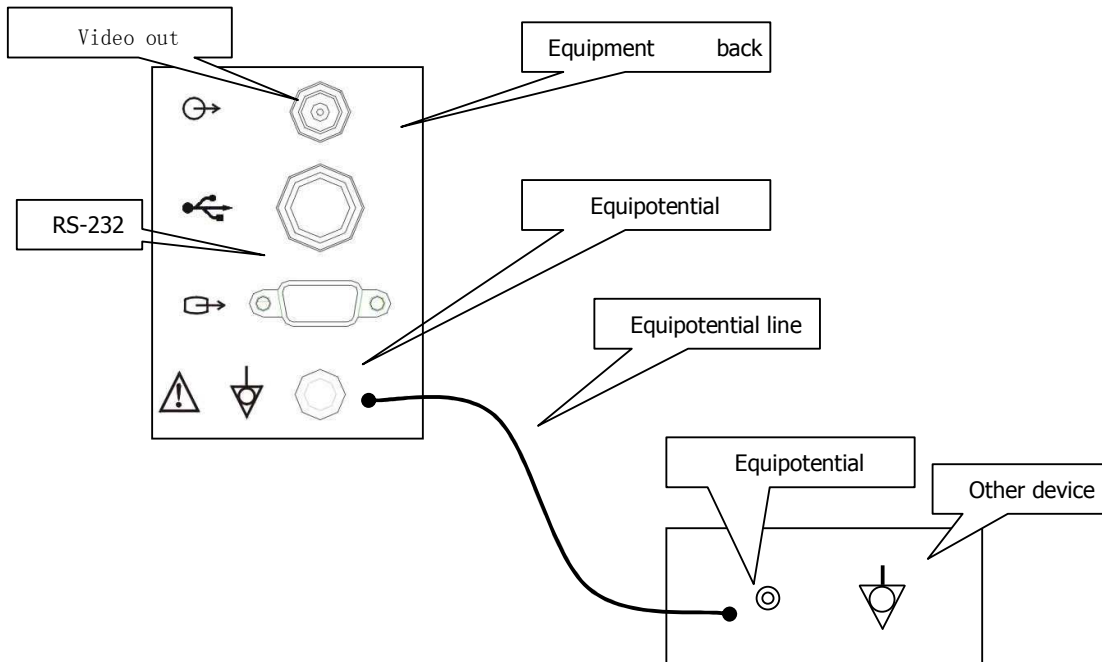

Warning

Equipotential: When this equipment is together used with other device, equipotential should be in consideration.

When the equipment is in use, the doctor and patient are under the risk of uncontrollable compensating current influence, which is caused by different electric potential between facilities and tangible current carrying parts. The most safe solution is set up a united equipotential network, and connect the medical equipments with the equipotential network in the treatment room.

5 Keyboard and Trackball Operation

5.1 Screen display

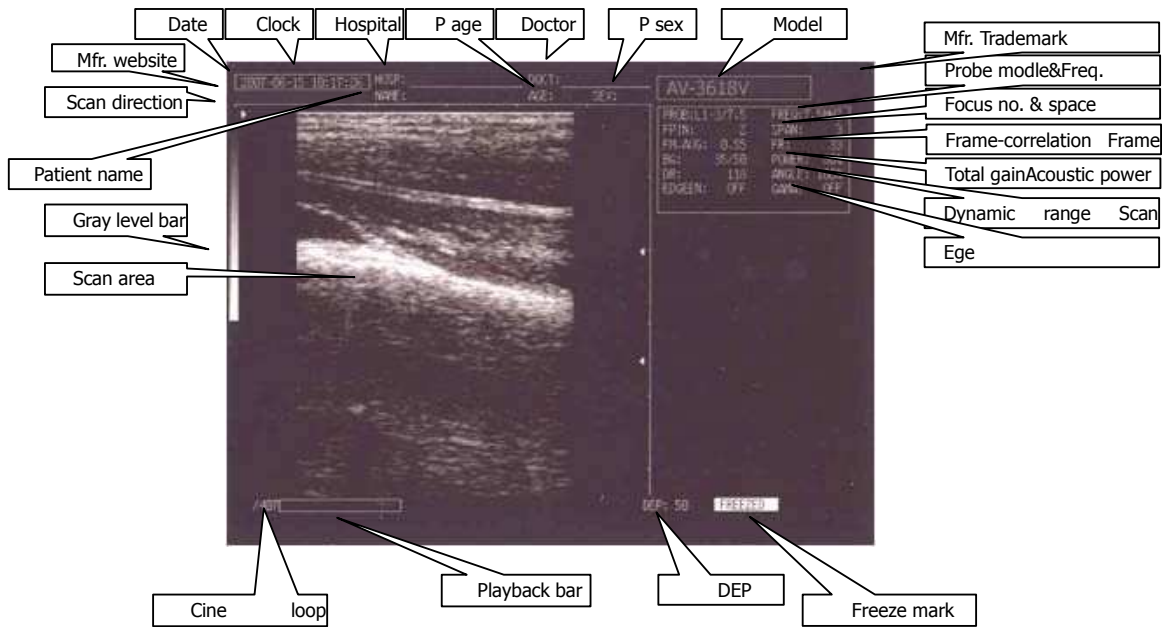

Figure 5-1 Equipment interface illustration

5.2 Operating keyboard

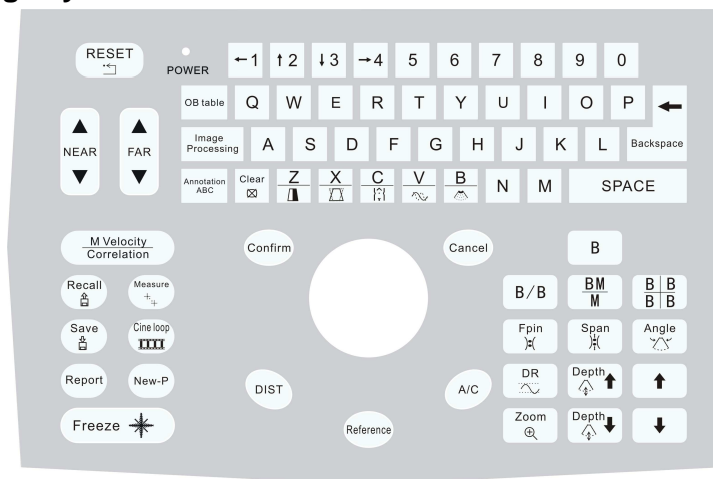

Figure 4-2. Operating keyboard sketch



Alphabet keys

Press these keys at annotation mode to put in characters at the cursor position. Among the alphabet keys, there are some keys with dual functions:

SN	Key	Function
1		At freeze, press this key to enter or exit report interface
2		At real time or freeze, press this key to adjust acoustic power
3		At real time or freeze, press this key to clear notation and report information on the image or the characters area
4		Total gain control key. There are four steps: 25, 30, 35, and 40. Press this key to set them circularly



Space key

At annotation, press this key to input space after cursor.

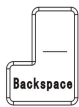

Backspace key

At annotation, press this key to delete the input characters.



Number

Numbers are used for time, date settings, age notation and function menu and selection.

There are the following dual functions keys:

SN	Key	Function
1		Press this key to move cursor or sampling line left
2		Press this key to move cursor up
3		Press this key to move cursor down
4		Press this key to move cursor or sampling line right
5		Control the cursor moving speed by direction keys



Clear

Press this key to clear off the measuring marks, notation data and measurement results on the image (When some menu is displayed, it can not be cleared until the current task is finished).



Notation

Press this key to display the notation menu, and press the above mentioned numbers or letters for notation.



OB Table

Press this key to display the OB table, and press the number keys to carry out the corresponding function.



Image Post-process menu

Press this key to display image post-process menu, and press the number keys to carry out the corresponding function.



Reset

Press this key to restart the system when malfunction and misoperation make the system "DEAD" (unable to start the system by pressing any other key).





Frame-correlation factors regulation/M mode velocity option

This key has two functions.

At "B/M" or 'M' mode, enter real time state; press this key to adjust the refresh velocity of "M mode image". There are four levels: 3.00S、2.50S、2.00S、1.25S. Press this key repeatedly to set the velocity circularly. The current velocity displays on the right of the screen.



At "B", "B/B" and "4B" modes enter real time state; press this key the "frame correlation factors." will display on the right top of the screen, then press the  or  to adjust the parameters of frame correlation factors. The system provides eight factors: 0.25、0.35、0.45、0.55、0.65、0.75、0.85 and 0.95, . Press the continuous key, the eight factors is setting circularly. The current parameter appears on the right top of the

screen (see figure 4-1).



Probes conversion key

This equipment is fitted with two probe connectors (A, B). Press this key to convert the probes. The current probe model appears on the right top of the screen (see figure 4-1). The probe model and their codes are:

LV2-3	LV2-3/6.5MHz Rectal Linear probe
C1-8/20R	C1-8/20R/5.0MHz Micro-convex probe
C1-7/60R	C1-7/60R/3.5MHz convex probe
EC1-2/13R	EC1-2/13R/6.5MHz Transvaginal probe
L1-3	L1-3/7.5MHz linear probe or EL1-3/7.5MHz Endo-rectal probe

Tips:

- *The device can automatically identify probes.*
- *When it is connected with two probes. The system default working probe is the one connecting to socket A.*
- *Please shut down the system first before replacing probes. Restart the system, it can realize automatic with default setting.*



Save image

At real time of freeze, press this key to save the current image: See "5.5.1 Image saving" for details.



Load image

Press this key to recall the stored image; See "5.5.2 Image loading" for details.



Image up-down

Press this key to flip image up and down. As given below:

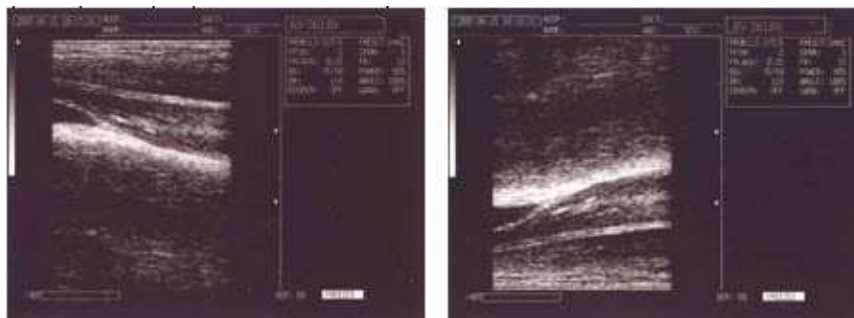

Figure 5-3. Image up and down flip sketch



Image left-right

Press this key to flip image left and right. As given below:



A



B

Figure 5-4. Image left and right flip sketch

Probe scan direction mark (in red circle) is the mark for image left and right flip. The default scan mode is figure A



Probe frequency conversion key

Press this key to change the working frequency of the probe. The frequency of each probe is given bellow:

- LV2-3 — 5.5MHz、6.5MHz、7.5MHz (LV2-3/6.5MHz Rectal Linear probe)
- C1-7/60R — 2.5MHz、3.5MHz、5.0MHz (C1-7/60R/3.5MHz convex probe)
- C1-8/20R — 4.5MHz、5.0MHz、5.5MHz (C1-8/20R/5.0MHz micro-convex probe)
- EC1-2/13 — 5.5MHz、6.5MHz、7.5MHz (EC1-2/R13/6.5MHz Transvaginal probe)
- L1-3 — 6.5MHz、7.5MHz、8.5MHz (L1-3/7.5MHz Linear probe EL1-3/7.5MHz En do-rectal probe)

The current probe frequency displays on the top right of the screen (see figure 4-1).



Measurement key

For volume, fetus weight measurement and histogram (see 5.4 for details).



Body mark keys

Preinstall function



Cine loop

At freeze state, press this key to enter cine loop, see "5.5.3 Cine Loop" for details.



Backlight Keyboard Backlight switch key

Press the Backlight key, switch on or switch off the Backlight of the keyboard



Print key

Preinstall function.



Measurement operation key

For distance, circumference, area, volume measurement operating. See Chapter 5.4.



Confirm key

Operate the trackball to select the option in menu.

Confirm the contents when noting.

At real time or freeze process, press this key to display azimuth mark ↖ .



B model display key

At free position, press this key to enter B mode (default mode is single B at starting up).



Double B mode display key

Press this key to enter BB mode. And there will be two B mode images displayed on the screen. One of them is a "Frozen" image and the other is a "real-time" image; Repress this key can make the two images switch between those two "Frozen" and "real-time" modes. Press "Freeze" key can freeze these two images.



BM/M mode display key

Press this key to enter B/M mode. B mode and M mode images will be displayed on the screen ("BM" or "B+M" for shortened form). At the same time, B mode real time image is on the left and M mode real time image is on the right.

Press this key again to enter M mode, then M mode image will be displayed on the screen. (Press this key to convert from BM to M, M to BM.)



4B mode display key

Under the single B or BB mode, press this key to enter 4B mode and display 4B mode images. One is real time, the other three are all frozen images; Press this key repeatedly to switch each image between "freeze" and

"real time" circularly. Press the freeze key to get four "Frozen" images.



Single B mode



BB mode

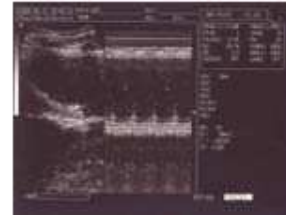

BM mode

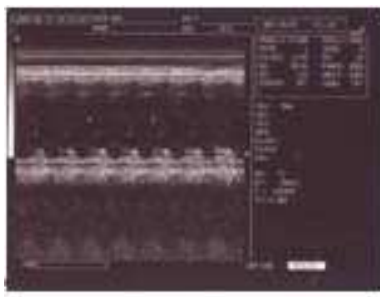

M mode



4B mode

Figure 5-5. Five display modes sketch



Adjusting keys

Adjusting keys are used to adjust focus position, dynamic range, scanning angle, zoom, cine loop See" Chapter 5 Operation Procedures")



The number of Focal point selection key

Press this key to lighten up the "focus number" on the screen right top, press again to change the focus numbers. There are maximum two focuses. Press this key to switch between one to two focus





Focus space selection

When set the focus number as two, their distance can be adjusted. There are 5 levels focus space 2, 3, 4, 5, 6 and press this key repeatedly to switch among them circularly.



Scan angle selection key



Press this key to lighten up the "Angle" on the Top right screen, press  or  to change the scanning angles. The angel range is physical scanning angles among 50%-100%.

Tips: When linear probe or rectal linear probe is used, this function can not be used. Reduce the

angle can improve the image's frame rate and increase the cine loop frames





Dynamic range adjusting key

Press this key to lighten up "DR" on the screen top right corner. Press  or  key to adjust the range. The equipment's adjust dynamic range among 100dB-131dB. Default is recommended.



Depth Adjusting key

Press  or  keys to adjust scan depth. The current depth displays at the bottom of screen (see figure 5-1). The depth adjusting range of each probe is given below:

Probe Model	LV2-3/6.5MHz Rectal Linear probe	EL1-3/7.5 MHz Endo-rectal probe L1-3/7.5MHz Linear probe	C1-7/60R/3.5 MHz convex probe	EC1-2/13R/6.5 MHz TV probe
Depth range(mm)	60~130	40~90	70~240	50~120

Table 5-1. Probes and their depth adjusting range table



Zoom key

At real time or freeze state, press this key to display or close sampling windows and zooming window.

Move the trackball can control the "zooming window" and the "sampling window". Press  Key to switch the current moving window.



Figure 5-6. Zoom sketch

Tips:



In order to change the sizes of “zooming window” and “sampling window”, press  or  keys. At the same time, the both windows’ sizes are changed pro rata. The maximum size of zooming window is a quarter of the image, which is displayed on the area of the screen.



Image freeze key

Press this key to switch between freeze and real time display.

Tips: The screen’s right bottom is displayed a “freezen”, which means the image, has been frozen.

5.3 Track ball

Track ball is fast, convenient in operation. In this equipment, the trackball functions show as below:

- Move measuring mark during measurement.
- Select these items in the menu during operation.
- Move the cursor at annotation state.
- Move the sampling line at BM mode.
- Display the puncture guide line’s and moves it.
- Control movie replay on single frame show at cine loop mode.
- Move the sampling window and zooming window at zooming state.
- At histogram statistic mode, Move the statistic sampling window.

Tips:

- do not press the trackball too heavy when operating the trackball.
- Keep the trackball surface clean.

6 Operation Procedures

6.1 Getting started

Switch on the equipment's rear panel power, indicator light shows on the panel and the start interface displays

on screen. Press any key (except  key) to enter the state of scanning. Adjust the monitor's brightness, contrast knob, TGC and overall gain (GAIN) to acquire a satisfied visual effect.



Figure 6-1 Start interface

6.2 Diagnosis

Apply some coupling gel on the diagnoses part of the patient and press the probe acoustical window close contact with this part. The Section of the tissue image pattern will display on the screen, move the probe slightly to find out the proper depth and optimum position; at the same time, adjust the brightness, contrast, overall gain (GAIN), 8 segment TGC to acquire the best section sonogram of the part.

Tips:

Adjust the total gain (GAIN) knob slowly.

Note

1. Do not press the probe too heavy and avoid breaking the probe or causing discomfort.
2. Do use proper probe and frequency to exam the target part.

6.3 Menu overview

Press  key to activate notation menu. Show as below:

- 1. NAME
- 2. AGE
- 3. SEX
- 4. COMMENT
- 5. TIME
- 6. HOSP
- 7. DOCT
- 8. LANGUAGE
- 9. ERASE
- A. EXIT

Figure 6-2 Notation menu

Press key to select "1. NAME" to enter the patient name, 15 characters maximum can be put in (letter, number or space), press to delete the input mistakes. (Same as the following comment) The name input box will appear on screen as follows:

PLEASE ENTER NAME:

After input, press any key (except letters and number keys) to exit. To cancel input, you can press any key. The name will display in "NAME" on the top of the screen. For example: press the character keys input WANG NING, then press any non-character key (e.g.) to finish input.

Press to select "2. AGE" to input patient's age, 3 characters input maximum. The age input box is listed below:



PLEASE ENTER AGE:

After input, press any key (except letter, number keys) to exit. To cancel input, you can press any key. The age will display after "AGE" on the top of the screen. For example: input 27, then press any non-number key (e.g.) to finish input.

Press select "3. SEX", input patient's sex. The input box is listed below:



PLEASE ENTER SEX:

1. MALE 2. FEMALE

Press  to select "1. MALE", and press  to select "2. FEMALE".

Press  to select "4. COMMENT" to enter image notation. The white cursor will display on the screen. Move the trackball cursor, you can annotate anywhere within the image area. At the same time the bottom of the screen will display the Chinese character's shortcut key, press the corresponding number keys (0-9), the cursor will input the same characters.

When finishing the comment, press "COMMENT" key on the board to end this operation or press  to cancel the comment.

Tips: At real time or freeze state, press  to approve the location mark, then press  to change the mark's direction, use the direction key or trackball to mark the image area or body specimen.

Press  to select "5. TIME" to modify the system's time and date. The time and date input box is listed as below:

YY-MM-DD
HH-MM-SS

For example, the date and time are: 2006-9-22 9:35:30, then the input should be:

YY-MM-DD
060922
HH-MM-SS
093530

Press  to select "6. HOSP" to input hospital name, input letters or numbers maximum 18 characters. The hospital name input box is listed below:

PLEASE ENTER HOSP: █

After input, press any key (except letter and number) to confirm exit. To cancel input, you can press any key. The hospital name will display after "Hospital" at the bottom of the screen. (see figure 4-1 shows)

Press  to select "7. DOCT" to put in doctor's name in letter or number maximum 15 characters. The doctor name input box is listed below:



PLEASE ENTER DOCT:



Press  to select "8. LANGUAGE", choose the system's interface language. The language selection box is given below:

PLEASE ENTER LANGUAGE:
1. CHINESE 2. ENGLISH



Press number key  to select Chinese and  to select English.



Press  to select "9. ERASE", erase image's storage section. The remind box is given below:

ERASE ALL STORAGE?
1. YES 2. NO



Press number key  to confirm clearance. When processing, a word "ERASING..." displays on the upper left screen to indicate that system is processing clearing and no other operation can be done at this moment. When the reminder disappears, the image storage is cleared.



Press  to give up and exit.



Press  to select "A. EXIT" to exit comment menu.

Tips:

● **When image storage erasing is in process (system reminds "Erasing..."), please do not take other operations in case the equipment was damaged.**

● **The trackball can be used for operating the menu: when the menu displays, move the trackball up**

and down to select the items, when the selected item is lightened, press  "confirm" to enter it.

●  **key functions:**

At the real time or freeze states, press this key to clear all the information about the patient.

 **Key functions:**

1. at real time or freeze state, press this key to clear off the measure marks, comments, measurement results, doctor, name, age and sex in image area

2. At report interface, clear off all the information and measurement results except "Hospital", "doctor" and "comment" information.

6.4 Measurement

Distance, circumference, area and volume can be measured by controlling the direction keys or trackball; Unit of distance and circumference is mm, unit of area is mm² and volume is cm³.

There are four measuring marks corresponding to measurement display:

+: D1

x: D2

※: D3

✳: D4

In circumference, area measurement, there have two measuring marks corresponding to measurement display as below:

+: C1, A1

x: C2, A2

6.4.1 Distance measurement

Operation steps:

1. Press  "DIST" key, and the first cursor appears on the screen;

2. Press  "Reference" key, the second cursor appears on the screen;

3. Move the cursor to the start point of this measurement by controlling the trackball, press  "Reference" key again to confirm the start point;

4. Move another cursor to the end of this measurement, press  "Cancel" to fulfill the measurement and

exit; **(Tips:** Press  "Reference" key repeatedly to switch between the start and end points of the measurement).



5. Continue to measure just repeat step 1-4 to get at most 4 groups of distance measurement. The measuring results display on the right below of the screen as the following figure shows:



Figure 6-3. Distance measurement sketch

C1 and A1 are the circumference and area of the first group data;
 C2 and A2 are the circumference and area of the second group data;
 C1/C2 is the ratio of the two circumferences;
 A1/A2 is the ratio of the two areas.

b. Ellipse measuring method

1. Press  key to select Ellipse method, an ellipse measuring mark display on the screen, which is named the measured area, can be moved to any place on the image by trackball.
2. Press  key, then move the trackball to change the size of this measured area. Move trackball left and right, the measured area shrinks or enlarges horizontally; Move trackball up and down to shrink or enlarge the measured area vertically;

Tips:

- Press  key repeatedly to shift between moving the mark and adjust the size by trackball.

3. Press  key, Move trackball to adjust the angle of the measured area.

4. Press  key to finish measuring.

5. Press  key and repeat the above steps 2-4 to process another measurement. Two group's data can be measured at most. And the measuring results display on the screen right as below:



Figure 6-5 Circumference and area measuring sketch (Ellipse method)

C1 and A1 are the circumference and area of the first group data;
 C2 and A2 are the circumference and area of the second group data;
 C1/C2 is the ratio of the two circumferences;

A1/A2 is the ratio of the two areas.

Note:

Ellipse measuring method only achieve under the freeze state.

6.4.3 Volume measurement

Volume can be measured in two ways.

1. Volume measurement utilizes 3-axle method to measure 3 groups of distances' dates to calculate from them.

To fulfill volume measurement must measure three times of distances and then press  key to get the volume.

If the measured distance data is less than three groups, pressing  will not get the volume; If four

distances information are measured, when pressing  key, the result is the value of the first three data(D1, D2, and D3) to calculate the results.

Operation procedure: (take kidney as an example)

1. Get the kidney cross section image and profile section image respectively and freeze them.
2. Measure the long axis and short axis lengths of kidney cross section with distance measurement method,
3. Measure the longitudinal profile se of kidney's diameter.
4. Press  key to fulfill volume measurement. The volume cost displays at the right corner of the screen behind "Vm1" as the following figure shows:



Figure 6-6. volume measurement sketch (3-axil method)

2. Utilizes ellipse measuring method to measure 2 groups of areas and then calculate them.

Operation procedure: (take kidney as an example)

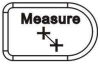
1. Get the kidney cross section image and profile section image respectively and freeze them.
2. Measure the kidney cross section circumference and area with circumference and area measuring method.



3. Press **Cancel** key to fulfill measurement. The volume cost automatically displays at the right corner of the screen behind "Vm1" as the following figure shows:



Figure 6-7 volume measurement sketch (Ellipse method)

Tips: If only one group of circumference and area are measured, Volume will not be displayed.

6.4.4 Cardiac rate measurement (only at B/M modes)

1. At B/M modes, move trackball to change the sampling line position and freeze it, and acquires a satisfying heart beat oscillogram.
2. Measure the distance between the three cardiac cycle's wave peaks according to distance measurement method. 4 groups data display at screen lower-right corner, from the left to right, they are: heart rate (HR) (unit: per rhythm /per minute.), rate of slope (EF) (unit: mm/s), time (T) (unit: ms), refresh velocity (ST) (unit: s). as following figure shows:

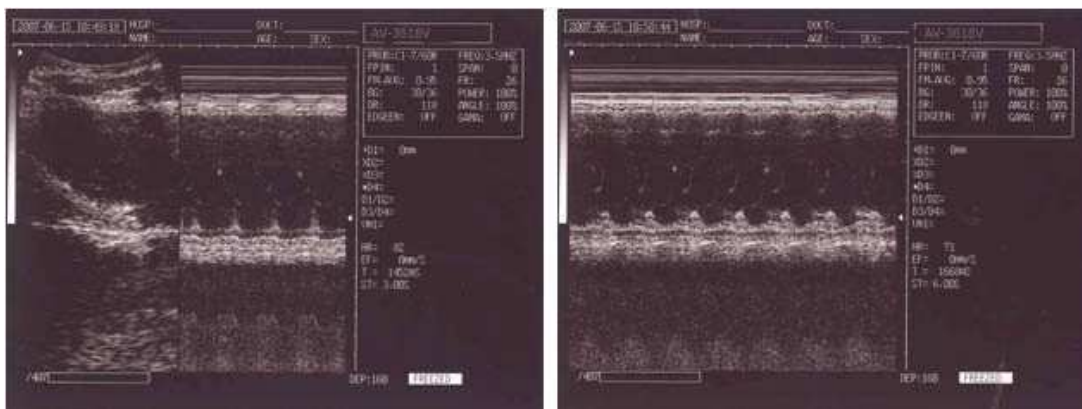







Figure 6-8. Heart rate measurement

Tips:

•Please identify the functions of  key and  key: Press  key to delete

measuring marks and results, press  key to clear off all annotation notes (including Doctor, name, age and sex) and measuring marks, results as well as report data.

•You can fulfill measurement by operating     direction keys as well as trackball.



6.5 Save and switch to storyboard view mode

The system provides separate memory area for "storyboard view" and "image save ".

6.5.1 Saving a image



•When getting a satisfying image, press  to save the current image. At the same time, the current stored image serial number automatically displays at left top corner of the image area. Such as "SAVING.....05". When the image's saving is finished, the serial number will disappear. After the saving, the system enters a

freeze mode, press  key to return to real time state.

•The equipment can store 32 images at most, and these images will be automatically numbered by their saving order. For example: The number 01- 20 images has already been saved, press  key, then the currently saved image will be numbered 21; When the memory is full (i.e. Already 32 images in it), then pressing  key, the screen will display as below:

STORAGE IS FULL.ERASE NO.01?

1. YES 2. NO

Tips replace the stored image number 01; press key  to replace it with current image; press key  to exit this operation.

Select "2 No" to abandon saving image. then "Save" again, the system will remind you if you want to cover image number 02, reason by analogy in turn.

Tips:

•When the image memory is full, if some saved images are reloaded, then processing the saving operation, the system will remind you if you want to delete this loaded image and save the current there from this serial number.

6.5.2 View a saved image

At real time or freeze, press "Load" key to display the following dialog box:

Please put in image number:



Input the saved image number, e.g. 01, then presses any key (except numbers and letters. Press  backspace key to clear the mistakes and input again to load the first image). On the screen left bottom, **01/32**

means: 01 is the serial number and 32 is the total amount of saved images in the memory. Press 



to load other images. Press









key to return to real time or freeze state. Repeat the above steps to load other images.

Tips:

- You can not load any image from an empty memory area.
- The input number should be from 01 to 32, when the input number is more than 32, the system will not take any operation.

6.5.3 Review storyboard mode

After starting up, system has entered the real time state, first collect **cine loop images**; it will last for 30 seconds.

1. Switch the equipment into freeze mode. Press  key to review images in circulation.
2. During review, press  or  to enter manual review mode. Press  to play increase image by frame, and press  to play decrease by frame. And press  key to return to auto-review mode.
3. When review at "B", "B/B" mode, switch between "B/B" and "B" to play the images in difference windows.
4. To exit **cine loop**, press  key.

Tips:

- If changing the image scanning mode, probe or display mode, cine loop can not be processed immediately. Normally cine loop can be done 30 seconds after scanning.
- At cine loop mode, roll trackball can play cine by single frame. When roll trackball up, cine is played from small number to big, roll it down, the reverse. Press "Cine loop" key to go on auto

playback.

- **Replace probe or change the scan angle, the cine loop frame may change .The standard results depend on the display data on the left bottom of the screen.**

6.6 Obstetrical calculation

The device provides gestation age measurement for horse, cows, sheep, pigs, cats, dogs and other animals through parameters such as GS, BL, HL, SL, USD, HD, BD, CRL, etc. to automatically display the relevant gestation age (gestation weeks).

Operating steps:

- Press  key to display menu

- | |
|-----------------|
| 1. EQUINE - GSD |
| 2. BOVINE - BL |
| 3. BOVINE - SL |
| 4. BOVINE - HL |
| 5. SWINE - HL |
| 6. SHEEP - USD |
| 7. CAT - HD |
| 8. CAT - BD |
| 9. DOG - GSD |
| A. DOG - CRL |
| B. DOG - HD |
| C. DOG - BD |
| D. EXIT |

Figure 6-9 the obstetrical table sketch

Repeat the above operation to select the required obstetrics table circularly (It can be showed the expected date of childbirth of DOG and CAT).

After that, select the distance parameter according to distance measurement method, the corresponding gestation age data will be automatically showed below "G·A=", the expected date of childbirth will be automatically showed below "EDD=", details are given below:

1. EQUINE: Estimate horse gestation age according to GS

Check routine on horse:

- ①. Clean out the excreta in horse's rectum.
- ②. Palpate by hand and preliminary estimate the gestation state to determine the germinal tissue for B ultrasonic scanning.
- ③. Hold the probe, and insert it into the rectum with hand on the probe closely to ensure that your hand will feel any following situation firstly. Position your hand dorsal part between the rectum wall and the transducer.
- ④. The internal structure of horse is displayed on the screen. Bladder lies in the vertical crossed part, the

following parts are cervix tissue and uterine body. Observe horizontally, uterine horn usually looks in round shape. Move the probe inside the rectum until the coupling section of uterine horn and uterine body is displayed, and then diverse the transducer to the direction of uterine horn as the following figure (Figure 6-10) shows:

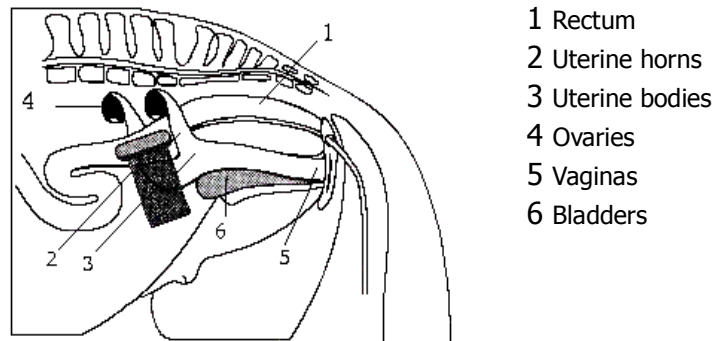

Figure 6-10. Probe position in womb and ovary sketch

- ⑤. The measuring method of GS diameter is given in the following figure (Figure 6-11). It can go in horizontal direction or vertical direction with no difference.

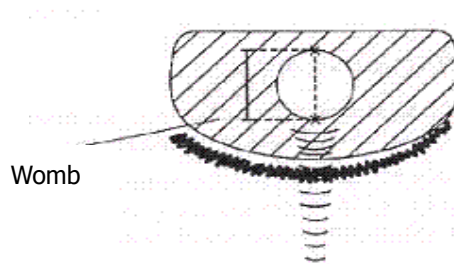

Figure 6-11. Horse's gestation age measurement sketch

- ⑥. Measure selected parameter distance according to distance measurement method, the corresponding gestation age data will automatically shows behind "G·A". Through measurement, a chart can be made to determine growth curve and hereby to judge the gestation age corresponding to the embryo size. Gestation age calculation begins from the copulation day instead of the impregnation day.

2. Moo-cow - BL: Estimate gestation age according to cow body length.

Check routine on cow:

- ①. Clean out the excreta in cow's rectum.
- ②. Palpate by hand and preliminary estimate the gestation state to determine the germinal tissue for B

ultrasonic scanning.

- ③. Hold the probe, and insert it into the rectum with hand on the probe closely to ensure that your hand will feel any following situation firstly. Position your hand dorsal part between the rectum wall and the transducer.
- ④. The internal structure of cow is displayed on the screen. Bladder lies in the vertical crossed part, the following parts are cervix tissue and uterine body. Observe horizontally, uterine horn usually looks in round shape. Move the probe inside the rectum until the coupling Section of uterine horn and uterine body displayed, and then diverse the transducer to the direction of uterine horn as the following figure (Figure 6-12) shows:

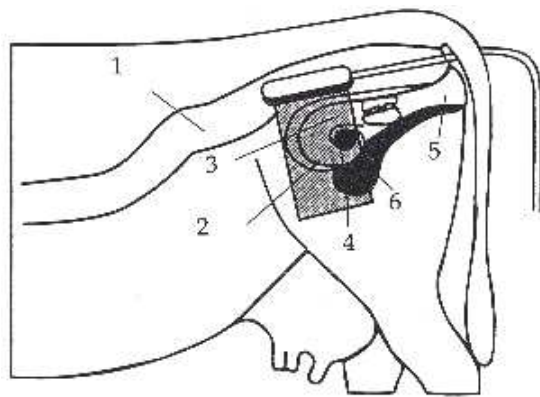

- 1 Rectum
- 2 Uterine horns
- 3 Uterine bodies
- 4 Ovaries
- 5 Vaginas
- 6 Bladders

Figure 6-12. Probe position in womb and ovary sketch

- ⑤. To measure fetal body diameter, a vertical Section should be selected, that is a plane covers from both sides through fetal neck, chest cavity and abdomen. Body diameter could be measured within 60 to 150 days gestation.

Body diameter measuring method is given in the following figure:

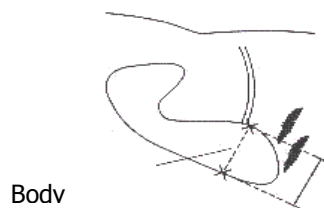

Figure 6-13. Cow's body length measurement sketch

- ⑥. Measure selected parameter distance according to distance measurement method, the corresponding gestation age data will automatically shows behind "G·A".

3. Moo-cow – SL: Estimate gestation age according to cow stomach length.

- ①. Make the cow in a state of stand.
- ②. Put the probe, a little bit left or right of the centre, on the ventral abdominal wall closely. If the is mud on this part, clean with water first incase the abdomen pelvic structure could not be displayed accurately.
- ③. The screen should be big enough to display the maximum stomach longitudinal length. With the growth

of gestation age, the fetal stomach macro-axis increases regularly. Measuring method of stomach maximum macro-axis is given in the following figure:

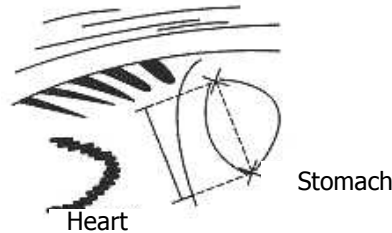

Figure 6-14. Cow's cardiac measurement sketch

- ④. Measure selected parameter distance according to distance measurement method, the corresponding gestation age data will automatically shows behind " G·A ".

4. Moo-cow - HL: Estimate gestation age according to cow heart length.

- ①. Make the cow in a state of stand.
- ②. Put the probe, a little bit left or right of the centre, on the ventral abdominal wall closely. If the is mud on this part, clean with water first incase the abdomen pelvic structure could not be displayed accurately.
- ③. To measure the heart macro-axis, screen should display the maximal longitudinal axis of heart. With the growth of gestation age, the fetal heart macro-axis growths regularly. Measuring method of maximal macro-axis of heart is given in the following figure:

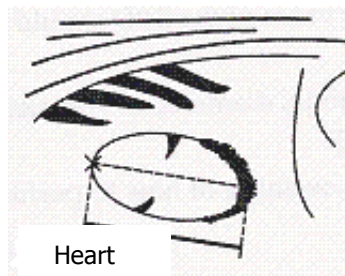

Figure 6-15. Cow's heart macro-axis measurement sketch

- ④. Measure selected parameter distance according to distance measurement method, the corresponding gestation age data will automatically shows behind " G·A ".

5. SWINE-HL: estimate gestation age according to pig heart length

Check routine on pigs:

- ①. Make the cow in a state of stand.
- ②. Put the probe, a little bit left or right of the centre, on the ventral abdominal wall closely along the side of teats and skull to rear leg. If the is mud on this part, clean with water first incase the abdomen pelvic structure could not be displayed accurately.

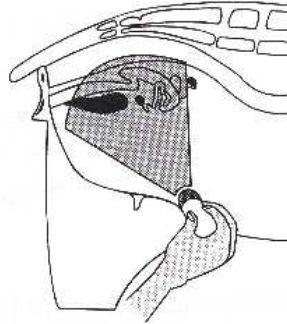

Figure 6-16. Pig's gestation age measurement position sketch

- ③. To measure the heart macro-axis, screen should display the maximal longitudinal axis of heart. With the growth of gestation age, the fetal heart macro-axis increase regularly. Measuring method is given in the following figure:

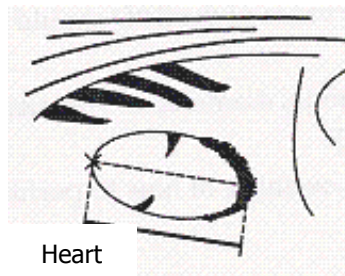

Figure 6-17. Swine heart macro-axis measurement sketch

- ④. Measure selected parameter distance according to distance measurement method, the corresponding gestation age data will automatically shows behind "G·A".

6. SHEEP-USD: Estimate gestation age according to hilum-spine length of sheep

There are two methods to check pregnant ewe with B ultrasound:

Use convex probe or linear probe check the abdomen; and recta probe for rectum. These two methods are both quite useful to diagnose pregnancy. On the base of some publication, we agree that both the methods on pregnancy diagnosis are proved to be effective.

- With 35 days pregnancy, result of rectal way is more precise than that of abdominal way;
- During 35 to 70 days pregnancy, both are equally effective.
- After 70 days pregnancy, abdominal method would be better. This way would be more practical for the Bigger womb. Abdomen check

- ①. Abdomen check can be done when the ewe is standing, lying or squatting. Put the probe on the middle abdomen without fur and is set to be the proper position for checking in advance.
- ②. If the is mud on this part, clean with water first incase the abdomen pelvic structure could not be displayed accurately.

- ③. Measure the hilum-spine length.
- ④. Measure selected parameter distance according to distance measurement method, the corresponding gestation age data will automatically shows behind "G·A".

7. CAT - HD: Estimate gestation age according to cat head diameter

To measure the head diameter is to measure the interior maximum diameter of skull between ventral and dorsal part.

Measuring method of head diameter is given in the following figure:



Figure 6-18. Cat head diameter measurement sketch

8. CAT-BD: Calculate the gestation age according to cat BD

After fetal head formed, binary top diameter measurement becomes a routine in ultrasonic examination. The measuring method is:

According to distance measurement method to measure distance of selected parameters, the corresponding gestation age data will automatically show behind "G·A".

9. DOG-GSD: Calculate the gestation age according to dog gestation saccus diameter

The method is the same as that of horse.

A. DOG-CRL: Calculate the gestation age according to dog CRL

The method is the same as the cow's.

B.DOG-HD: Calculate the gestation age according to dog HD

The method is the same as the cat's.

C. DOG-BD: Calculate the gestation age according to BD

The method is the same as the cat's.



After measurement, press "清屏" key to clear the screen for the next measurement. Otherwise.

Press "D" to select "D. Exit" to exit OB table.

Tip: the system would not show the relative items when the distance is less than the measurements defined as the table below:

EQUINE - GSD	D1<6mm
BOVINE - BL	D1<8mm
BOVINE - SL	D1<1mm
BOVINE - HL	D1<3mm
SWINE - HL	D1<31mm
SHEEP - USD	D1<15mm
CAT - HD	D1<15mm
CAT - BD	D1<17mm
DOG - GSD	D1<1mm
DOG - CRL	D1<1mm
DOG - HD	D1<14mm
DOG - BD	D1<16mm

6.7 Diagnostic Report

The information of patient, diagnostic comments, measuring results as well as hospital, date, time, doctor will be saved in the report. System will generate a routine report page automatically according to different measurement items. Therein, distance, circumference, area, volume, ect. will be saved in Routine Report; measuring results such as gestation age, expected date of delivery, fetus weight, etc. will be saved in Obstetrics Report

●At any of the B, BB, BM, M, 4B mode, when fulfilling patient information comment, diagnoses, and foci

distance, circumference, area, volume measurements, keep the image in freeze state, press  key to switch to Routine Report interface as given below:

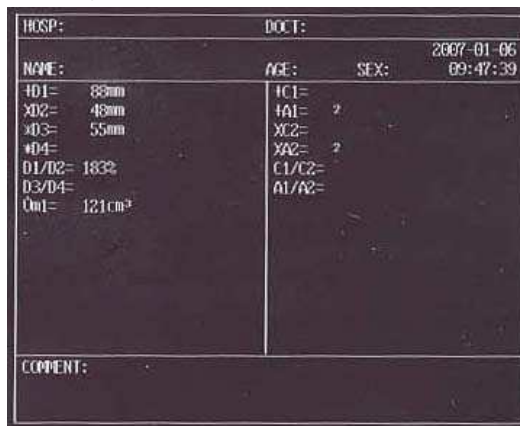



Figure 6-19. Routine report sketch

Tips:

● At report interface, press  key to add comments in comment frame but the other information can not be amended.

● Press  key repeatedly to switch between diagnoses interface and report interface.

6.8 Image Processing

Press  key to display the image processing menu (as below). It provides image positive-negative flip, GAMA calibration, statistic histogram, edge gain and other image processing functions.

1. Posi-Nega
2. GAMA calibration
3. Histogram
4. Edge enhancement
5. Exit

Press  to select "1. Posi-Nega" to change the image polarity as given below:



Figure 6-20. Polarity sketch

Press  to select "2. GAMA calibration" to lighten up "GAMA", on the top right corner of the screen.

There are 4 levels G1, G2, G3 and OFF, press   to select them circularly.

Tips:

● This function is set for video output and external devices (e.g. video printer) adjustment and is recommended to set at "OFF" during operation.

Press  to select "3. Histogram" to process histogram statistics as the following procedure:

At freeze, press " " key to display the menu, select "3. Histogram" to call out a rectangle window on the image, press "Measurement" key to calculate the gray scale pixel numbers. The result displays on screen right as the following figure shows:



Figure 6-21. Histogram sketch

Horizontal ordinate indicates gray scale degree, vertical ordinate indicates number.

PT indicates total quantity of pixel dots in the rectangular window.

Gm indicates the corresponding gray scale of the curve at the vertical peak.

Pm indicate the quantity of pixel dots at Gm gray scale.

From the above figure, in the rectangular area, the total number of pixel dots is 10000. At gray scale 28, there are 284 dots, the most image pixel dots.

Press  to select "4. Edge enhancement" to lighten up the "EDGEEN" on the top right corner of the screen. Then edge enhancement is adjustable. There are 9 levels: OFF, EE1-EE8 which can be adjusted by pressing.

Tips:

- **This function is a special item and recommended to set at "OFF" during operation.**

Press  to select "5. Exit" to exit the menu.

6.9 Image print

Connect the VIDEO IN port of the video printer to the VIDEO OUT port on rear panel of the equipment, then operate according to the video printer operation manual.

6.10 Image Upload to computer

Connect the USB communication port of the equipment to the computer's USB port.

The high speed USB2.0 mouthpiece can upload images to the computer at current time.

In the accompanying disc, there are USB device driver, image preview program Amcap and SDK documents for relevant redevelopment.

Install the USB device driver, open Amcap.EXE, and then you can view images according to the instruction files in the disc.

Using SDK documents in the disc, you can process redevelopment as required.

6.11 Shut down the equipment

Turn the power off.

Tips: It would be better to unplug the AC supply if do not use the equipment for a long time.

Note

Must not plug or unplug the power plug when the equipment is not shut down; If it needs to switch on the equipment immediately after just shutdown, please wait for 2 or 3 minutes to avoid breaking the equipment.

7 Check and Maintenance

7.1 Detect

Periodic detect the device power cord and probe cable, if find any damage or breakage, must not use the device and replace it immediately.

7.2 Effective Service life

Bases on the manufacturer’s design, production related files, this model’s use life is six years. The Product’s material will gradually aging, if the product continually use over the designed use life, it may bring the problem of the performance reduced and fault rate raise.

Note

**To Discard the device according to the local law.
Do not discard it mixing with other household garbage.**

Warning

The manufacturer shall not assume the responsibility of risks caused by using the device beyond its service life.

7.3 Host maintenance

Instrumentation environment should accord with "4.1 operation environmental requirement".

If device enclosure needs cleaning, shutdown the device first and then wipe with alcohol sponges. And only at the switch off condition open the device shell to use the blower to get rid off the dust.

When the device does not work for a long time, should pack the device according to the instructions in the package. Store it properly in the warehouse. The storage environment should accord with "8.1 Transportation and storage environmental requirements".

7.4 Probe maintenance

Probe is an expensive and frangible part. Never hit it or drop it on floor. When stop the working, place the probe in the box

and press  key to set the probe at freeze state.

Please use medical ultrasound coupling gel during diagnoses. The water prevention level is IPX7, so do not let water exceed the acoustic window (see figure 7-1, 7-2, 7-3, 7-4, 7-5). Do daily inspection on the probe enclosure to see if it is cracked and avoid liquid leakage to spoil the inner components

AV-3618V Digital Portable B mode ultrasound scanner

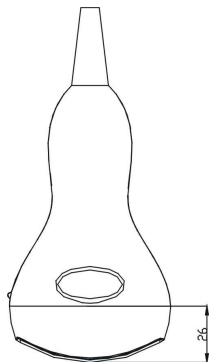

Figure 7-1.C1-7/60R/3.5MHz convex probe water-proof sketch



Figure 7-2. EC1-2 Endocavity probe water-proof sketch

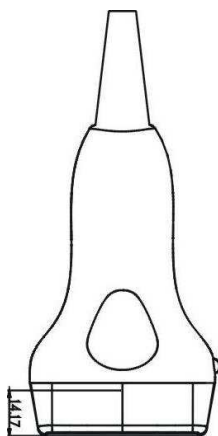

Figure 7-3.L1-3/7.5MHz HF linear probe water-proof sketch

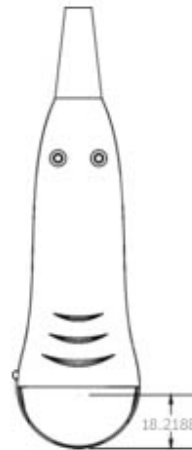

Figure 7-4.C1-8/20R/5.0MHz convex probe water-tight sketch

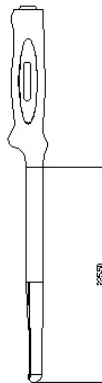

Figure 7-5 EL1-3/7.5MHz rectal probe water-proof sketch

Once the probe is connected to the main unit, do not remove it at will to avoid poor contact.

Note

Probe might be damaged due to long time covered coupling gel.

Note

Clean the probe head after every use.

Do not clean the probe with a surgical brash neither soft brash. Only soft cloth can be used to clean it.

Note

Do not press the probe on the patient too long to avoid discomfort.

7.5 Cleansing

1. When the enclosure needs cleaning, wipe it with soft dry cloths and then wipe gently with sponge dipped with 75% medical alcohol.
2. When the inner part of the equipment needs cleaning, power off the equipment first and open the enclosure and vacuum it.

Warning

To prevent accidents, please power off the equipment when cleaning it or the probe.

Caution

1. Please refer to instructions prescribed by the manufacturer closely when using detergents.
2. Be careful with cleaning of the display, because it is very easy to scratch and spoil. Please wipe it with dry soft cloth.
3. Please do not clean the inner part of the device.
4. Please do not place the device in liquid.
5. Do not leave any detergent on the device surface.
6. Though there will be no chemical reaction between the device enclosure and most of those detergents, We still suggest no detergent in cleaning lest the device surface is spoiled.

Warning

Must not use extender, ethylene oxide or any other organic solvent which tend to deface the probe's protective foil.

Must not place the probe in liquid or detergent.

Must keep the equipment or probe from any type of liquid's infiltration.

Must not clean device or probe by airing or heating.

7.6 Correctly use the probe

In order to extend probe's service life and obtain optimum performance, follow the instructions as below:

1. Periodic inspection on probe cable, socket and acoustic window.
2. Shutdown the device first and then connect or disconnect the probe.
3. Do not drop probe or flint body, and never hit the probe acoustic window, otherwise probe should be damaged.
4. Put the probe in the probe box when it is not in use.
5. Never heat the probe.
6. Never bend or pull probe cable, otherwise the internal connection should be broken.
7. Use coupling gel only on probe header and then clean probe.
8. Inspect probe acoustical window, enclosure and cable seriously after probe cleaning. Never use the probe again if any crack or breakage is found.

7.7 Equipment detection and calibration

1. Check the leakage current of the device annually referring to the following data.

Test Items			Standard Requirements
Continuous leakage current under normal temperature (uA)	Leakage current to Shell	Normal	≤100
		Single Malfunction	≤500
	Leakage current to Patient	Normal	≤100
		Single Malfunction	≤500
Dielectric endurance under normal temperature (V)		A- a ₂	4000V/1min No flashover No

2. Test the software of obstetrics, area, and circumference measurement; please refer to Appendix C for detailed data.

8 Transportation and Storage

8.1 Environmental Requirements of Transportation and Storage

Environmental temperature: - 40°C ~+55°C;

Relative humidity: 10%~100%;

Atmospheric pressure: 50KPa~106KPa;

8.2 Transportation

All marks printed on the packing box are in accordance with the requirements of GB191-2000 <Packing, Storage and Transportation Marks>. Simple shockproof installations are made in the packing box, which adapt to voyage, railway, and highway and steamship transportation. Avoid rain, inversion and impact.

8.3 Storage

- When the device is stored for more than 6 months, take out the device from the packing box. Electrify the device for 4 hours, and then put the device into the packing box according to the instructions way on the packing box. Do not crisscross/piling devices or keep the device to floor, wall and ceiling.
- Keep the repository ventilative. Avoid direct sunshine and caustic gas.

9 Simple Malfunction Examination and Troubleshooting

9.1 Examination

- Examine whether the supply power is in normal state. The power line of the main frame has been properly connected and inserted in the electric socket.
- Examine whether the probe has been connected to the device correctly.

9.2 Troubleshooting

- **Replacement of fuse**

Position the driver into the slot on the fuse cap and press it, then contra-rotate it to loose the cap. Take off the fuse tube (protective tube) and replace it then put back the cap and take the reverse measure to fix the cap and fasten it. Fuse specification: $\phi 5 \times 20, F2L250V$.

- **Troubleshooting (see the following diagram)**

No.	Malfunction phenomena	Troubleshooting
1	Open power switch of the device, with no signal appeared on the screen and the indicator light is not on.	1. Examine power supply; 2. Examine supply line and plug; 3. Examine whether the fuse is burned-out; 4. Examine the lightness adjusting knob of the monitor.
2	Discontinuous stria and snow appear on the screen.	1. Examine power supply: strike fire interfere of the other devices; 2. Environmental examination: Electric and magnetic field interfere; 3. Examine power and probe plugs: whether they are well connected.
3	Unclear image display	1. Adjust the brightness and contrast knobs on the front panel; 2. Adjust the 8 level TGC and the total gain knob on the front panel; 3. Clean the screen optical filter.
4	Unclear near field	1. Adjust the total gain knob on the front panel and the 8 level TGC; 2. Adjust the focus position to the near field;
5	Unclear far field	1. Adjust the total gain knob on the front panel and the 8 level TGC; 2. Adjust the focus number, space and position to set the focus in the far field.

Appendix A Labels Diagram

1. AV-3618V Main unit nameplate diagram :

Item	B-Ultrasonic Diagnostic Equipment	Model	AV-3618V
Power supply	AC110-130V/220-240V,50Hz/60Hz	Power Consumption	100VA
Manufactured		Serial No.	
Manufacturer		Safety	Class I Type B
ADD	5A,ShunTian Bldg,62 GuiMiao Road,Nanshan District,Shenzhen City,China		

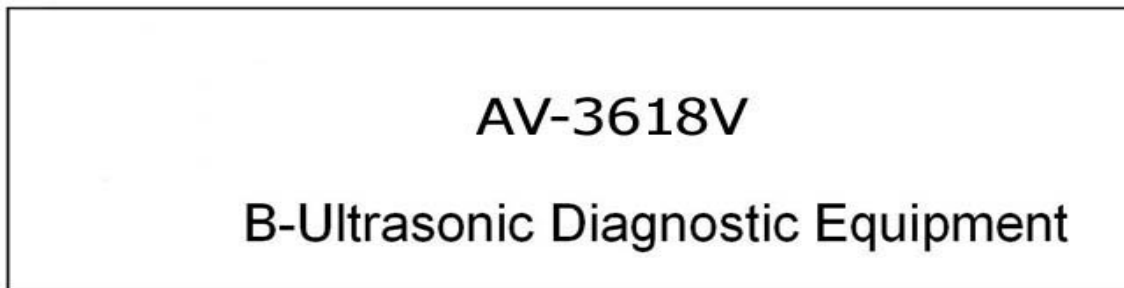



2. AV-3618V device probe nameplate diagram:

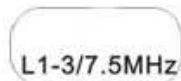

3. AV-3618V device optional probe nameplate diagram:



4.AV-3618V Packing diagram :

<p>B-Ultrasonic Diagnostic Equipment</p> <p>Storage and transportable condition</p> <p>Temperature: -40°C ~ +50°C Relative humidity range: 10% ~ 100% Atmospheric pressure range: 50kPa ~ 106kPa</p> <p>CE</p>  <p>MODEL: _____ Q. TY: 1 N.W: 9.5kg G.W: 12kg MEAS: 425x390x400mm³</p> <p>AMBISEA Technology Corp., Ltd</p>		<p>B-Ultrasonic Diagnostic Equipment</p> <p>Storage and transportable condition</p> <p>Temperature: -40°C ~ +50°C Relative humidity range: 10% ~ 100% Atmospheric pressure range: 50kPa ~ 106kPa</p> <p>CE</p>  <p>MODEL: _____ Q. TY: 1 N.W: 9.5kg G.W: 12kg MEAS: 425x390x400mm³</p>	
			

Above contents are subject to change without prior notice.

Appendix B Acoustic Output Parameters

Test Mode: B-mode

Transducer Type: C1-7/60R

No	Test Item	Requirements and Clauses	Results	Remarks
1	Maximum power (mW)	Maximum temporal-average power output. IEC 61157 4.2.2a)	72.4	
2	P ₋ (MPa)	Peak-negative acoustic pressure. IEC 61157 4.2.2b)	1.72	
3	I _{ob} (mW/cm ²)	Output beam intensity. IEC 61157 4.2.2c)	18.04	
4	I _{spta} (mW/cm ²)	Spatial-peak temporal average derived Intensity. IEC 61157 4.2.2d)	9.56	
5	System settings	Ultrasound instrument console settings. IEC 61157 4.2.2e)	Focus number:1 Power:80% Angle:57% Frame rate:34	
6	L _p (mm)	Distance form the transducer output face to the point of maximum pulse-pressure-squared integral. IEC 61157 4.2.2f)	40	
7	W _{pb6} (mm)	-6dB pulse-width. IEC 61157 4.2.2g)	(□): 1.59 (□): 8.50	
8	prr(kHz)	Pulse repetition rate. IEC 61157 4.2.2h)	Not applicable	
9	srr (Hz)	Scan repetition rate. IEC 61157 4.2.2h)	34.13	
10	Output beam dimensions (cm ²)	Dimensions parallel(∥)and perpendicular(⊥)to the reference direction shall be specified. For scanning modes, these shall refer to the central scan line only. In many cases, especially contact systems, these dimensions may be taken As the geometrical dimensions of the ultrasonic transducer or ultrasonic transducer element group. IEC 61157 4.2.2i)	4.013	Test frequency: 2.5 MHz
11	f _{awf} (MHz)	Arithmetic-mean acoustic-working Frequency. IEC 61157 4.2.2j)	2.78	
12	APF	Acoustic power-up fraction. IEC 61157 4.2.2k)	0%	
13	Power-up mode	In system in which the user defines the power-up mode, this shall be stated as either "user defined" or "not applicable"(n / a). IEC 61157 4.2.2l)	B-mode freeze	
14	AIF	Acoustic initialization fraction. IEC 61157 4.2.2m)	100%	
15	Initialization mode	If appropriate. in systems in which the user defined the initialization mode, this shall be stated as either "user defined" or "not applicable"(n / a). IEC 61157 4.2.2n)	B-mode	
16	Acoustic output freeze	If the system has acoustic output freeze then this shall be stated as "yes", otherwise it shall be stated as "no". IEC 61157 4.2.2o)	Yes	

Test Mode: B/M-mode

Transducer Type: C1-7/60R

No	Test Item	Requirements and Clauses	Results	Remarks
1	Maximum power (mW)	Maximum temporal-average power output. IEC 61157 4.2.2a)	64.6	Test frequency: 2.5 MHz
2	P ₋ (MPa)	Peak-negative acoustic pressure. IEC 61157 4.2.2b)	1.72	
3	I _{ob} (mW/cm ²)	Output beam intensity. IEC 61157 4.2.2c)	16.09	
4	I _{spta} (mW/cm ²)	Spatial-peak temporal average derived intensity. IEC 61157 4.2.2d)	33.89	
5	System settings	Ultrasound instrument console settings. IEC 61157 4.2.2e)	Focus number:1 Power:80% Angle:57% Frame ate:38 ST:1.00s	
6	Lp (mm)	Distance form the transducer output face to the point of maximum pulse-pressure-squared integral. IEC 61157 4.2.2f)	40	
7	W _{pbb} (mm)	-6dB pulse-width. IEC 61157 4.2.2g)	(): 1.59 (⊥): 8.55	
8	prp(kHz)	Pulse repetition rate. IEC 61157 4.2.2h)	0.222	
9	srr (Hz)	Scan repetition rate. IEC 61157 4.2.2h)	37.31	
10	Output beam dimensions (cm ²)	Dimensions parallel()and perpendicular(⊥)to the reference direction shall be specified. For scanning modes, these shall refer to the central scan line only. In many cases, especially contact systems, these dimensions may be taken as the geometrical dimensions of the ultrasonic transducer or ultrasonic transducer element group. IEC 61157 4.2.2i)	4.013	
11	f _{awf} (MHz)	Arithmetic-mean acoustic-working frequency. IEC 61157 4.2.2j)	2.78	
12	APF	Acoustic power-up fraction. IEC 61157 4.2.2k)	0%	
13	Power-up mode	In system in which the user defines the power-up mode, this shall be stated as either "user defined" or "not applicable"(n / a). IEC 61157 4.2.2l)	B-mode freeze	
14	AIF	Acoustic initialization fraction. IEC 61157 4.2.2m)	100%	
15	Initialization mode	If appropriate. in systems in which the user defined the initialization mode, this shall be stated as either "user defined" or "not applicable"(n / a). IEC 61157 4.2.2n)	B-mode	
16	Acoustic output freeze	If the system has acoustic output freeze then this shall be stated as "yes", otherwise it shall be stated as "no". IEC 61157 4.2.2o)	Yes	

Test Mode: B-mode

Transducer Type: C1-8/20R

No	Test Item	Requirements and Clauses	Results	Remarks
1	Maximum power(mW)	Maximum temporal-average power output. IEC 61157 4.2.2a)	34.8	Test frequency: 5.0 MHz
2	P ₋ (MPa)	Peak-negative acoustic pressure. IEC 61157 4.2.2b)	1.82	
3	I _{ob} (mW/cm ²)	Output beam intensity. IEC 61157 4.2.2c)	20.17	
4	I _{spta} (mW/cm ²)	Spatial-peak temporal average derived intensity. IEC 61157 4.2.2d)	25.74	
5	System settings	Ultrasound instrument console settings. IEC 61157 4.2.2e)	Focus number:1 Power:80% Angle:49% Frame rate:71	
6	L _p (mm)	Distance form the transducer output face to the point of maximum pulse-pressure-squared integral. IEC 61157 4.2.2f)	33	
7	W _{pb6} (mm)	-6dB pulse-width. IEC 61157 4.2.2g)	(): 2.55 (⊥): 3.43	
8	pr _r (kHz)	Pulse repetition rate. IEC 61157 4.2.2h)	Not applicable	
9	s _r r (Hz)	Scan repetition rate. IEC 61157 4.2.2h)	67.93	
10	Output beam dimensions (cm ²)	Dimensions parallel()and perpendicular(⊥)to the reference direction shall be specified. For scanning modes, these shall refer to the central scan line only. In many cases, especially contact systems, these dimensions may be taken as the geometrical dimensions of the ultrasonic transducer or ultrasonic transducer element group. IEC 61157 4.2.2i)	1.725	
11	f _{awf} (MHz)	Arithmetic-mean acoustic-working frequency. IEC 61157 4.2.2j)	3.89	
12	APF	Acoustic power-up fraction. IEC 61157 4.2.2k)	0%	
13	Power-up mode	In system in which the user defines the power-up mode, this shall be stated as either "user defined" or "not applicable"(n / a). IEC 61157 4.2.2l)	B-mode freeze	
14	AIF	Acoustic initialization fraction. IEC 61157 4.2.2m)	100%	
15	Initialization mode	If appropriate. in systems in which the user defined the initialization mode, this shall be stated as either "user defined" or "not applicable"(n / a). IEC 61157 4.2.2n)	B-mode	
16	Acoustic output freeze	If the system has acoustic output freeze then this shall be stated as "yes", otherwise it shall be stated as "no". IEC 61157 4.2.2o)	Yes	

Test Mode: B/M-mode Transducer Type: C1-8/20R

No	Test Item	Requirements and Clauses	Results	Remarks
1	Maximum power(mW)	Maximum temporal-average power output. IEC 61157 4.2.2a)	31.4	Test frequency: 5.0 MHz
2	P ₋ (MPa)	Peak-negative acoustic pressure. IEC 61157 4.2.2b)	1.82	
3	I _{ob} (mW/cm ²)	Output beam intensity. IEC 61157 4.2.2c)	18.20	
4	I _{spta} (mW/cm ²)	Spatial-peak temporal average derived intensity. IEC 61157 4.2.2d)	46.85	
5	System settings	Ultrasound instrument console settings. IEC 61157 4.2.2e)	Focus number:1 Power:80% Angle:49% Frame rate:66 ST:1.00s	
6	L _p (mm)	Distance form the transducer output face to the point of maximum pulse-pressure-squared integral. IEC 61157 4.2.2f)	33	
7	W _{pb6} (mm)	-6dB pulse-width. IEC 61157 4.2.2g)	(□): 2.12 (□): 3.99	
8	prr(kHz)	Pulse repetition rate. IEC 61157 4.2.2h)	0.228	
9	srr (Hz)	Scan repetition rate. IEC 61157 4.2.2h)	62.50	
10	Output beam dimensions (cm ²)	Dimensions parallel(∥)and perpendicular(⊥)to the reference direction shall be specified. For scanning modes, these shall refer to the central scan line only. In many cases, especially contact systems, these dimensions may be taken as the geometrical dimensions of the ultrasonic transducer or ultrasonic transducer element group. IEC 61157 4.2.2i)	1.725	
11	fawf (MHz)	Arithmetic-mean acoustic-working frequency. IEC 61157 4.2.2j)	3.89	
12	APF	Acoustic power-up fraction. IEC 61157 4.2.2k)	0%	
13	Power-up mode	In system in which the user defines the power-up mode, this shall be stated as either "user defined" or "not applicable"(n / a). IEC 61157 4.2.2l)	B-mode freeze	
14	AIF	Acoustic initialization fraction. IEC 61157 4.2.2m)	100%	
15	Initialization mode	If appropriate. in systems in which the user defined the initialization mode, this shall be stated as either "user defined" or "not applicable"(n / a). IEC 61157 4.2.2n)	B-mode	
16	Acoustic output freeze	If the system has acoustic output freeze then this shall be stated as "yes", otherwise it shall be stated as "no". IEC 61157 4.2.2o)	Yes	

Test Mode: B/M-mode
Transducer Type: EC1-2

No	Test Item	Requirements and Clauses	Results	Remarks
1	Maximum power (mW)	Maximum temporal-average power output. IEC 61157 4.2.2a)	29.4	Test frequency: 6.5 MHz
2	P ₋ (MPa)	Peak-negative acoustic pressure. IEC 61157 4.2.2b)	1.94	
3	I _{ob} (mW/cm ²)	Output beam intensity. IEC 61157 4.2.2c)	21.41	
4	I _{spta} (mW/cm ²)	Spatial-peak temporal average derived intensity. IEC 61157 4.2.2d)	39.01	
5	System settings	Ultrasound instrument console settings. IEC 61157 4.2.2e)	Focus number:1 Power:80% Angle:49% Frame rate:AO	
6	L _p (mm)	Distance from the transducer output face to the point of maximum pulse-pressure-squared integral. IEC 61157 4.2.2f)	26	
7	W _{pb6} (mm)	-6dB pulse-width. IEC 61157 4.2.2g)	(□): 1.47 (□): 2.41	
8	prr(kHz)	Pulse repetition rate. IEC 61157 4.2.2h)	Not applicable	
9	srr (Hz)	Scan repetition rate. IEC 61157 4.2.2h)	95.05	
10	Output beam dimensions (cm ²)	Dimensions parallel(∥) and perpendicular(⊥)to the reference direction shall be specified. For scanning modes, these shall refer to the central scan line only. In many cases, especially contact systems, these dimensions may be taken as the geometrical dimensions of the ultrasonic transducer or ultrasonic transducer element group. IEC 61157 4.2.2i)	1.373	
11	f _{awf} (MHz)	Arithmetic-mean acoustic-working frequency. IEC 61157 4.2.2j)	4.39	
12	APF	Acoustic power-up fraction. IEC 61157 4.2.2k)	0%	
13	Power-up mode	In system in which the user defines the power-up mode, this shall be stated as either "user defined" or "not applicable"(n / a). IEC 61157 4.2.2l)	B-mode freeze	
14	AIF	Acoustic initialization fraction. IEC 61157 4.2.2m)	100%	
15	Initialization mode	If appropriate. in systems in which the user defined the initialization mode, this shall be stated as either "user defined" or "not applicable"(n / a). IEC 61157 4.2.2n)	B-mode	
16	Acoustic output freeze	If the system has acoustic output freeze then this shall be stated as "yes", otherwise it shall be stated as "no". IEC 61157 4.2.2o)	Yes	

Test Mode: B/M-mode

Transducer Type: EC1-2

No	Test Item	Requirements and Clauses	Results	Remarks
1	Maximum power (mW)	Maximum temporal-average power output. IEC 61157 4.2.2a)	25.6	Test frequency: 6.5 MHz
2	P ₋ (MPa)	Peak-negative acoustic pressure. IEC 61157 4.2.2b)	1.94	
3	I _{ob} (mW/cm ²)	Output beam intensity. IEC 61157 4.2.2c)	18.64	
4	I _{spta} (mW/cm ²)	Spatial-peak temporal average derived intensity. IEC 61157 4.2.2d)	59.31	
5	System settings	Ultrasound instrument console settings. IEC 61157 4.2.2e)	Focus number:1 Power:80% Angle:49% Frame rate:AO ST:1.00s	
6	L _p (mm)	Distance from the transducer output face to the point of maximum pulse-pressure-squared integral. IEC 61157 4.2.2f)	26	
7	W _{pb6} (mm)	-6dB pulse-width. IEC 61157 4.2.2g)	(□): 1.46 (□): 2.34	
8	p _{rr} (kHz)	Pulse repetition rate. IEC 61157 4.2.2h)	0.233	
9	s _{rr} (Hz)	Scan repetition rate. IEC 61157 4.2.2h)	93.45	
10	Output beam dimensions (cm ²)	Dimensions parallel(∥) and perpendicular(⊥)to the reference direction shall be specified. For scanning modes, these shall refer to the central scan line only. In many cases, especially contact systems, these dimensions may be taken as the geometrical dimensions of the ultrasonic transducer or ultrasonic transducer element group. IEC 61157 4.2.2i)	1.373	
11	f _{awf} (MHz)	Arithmetic-mean acoustic-working frequency. IEC 61157 4.2.2j)	4.40	
12	APF	Acoustic power-up fraction. IEC 61157 4.2.2k)	0%	
13	Power-up mode	In system in which the user defines the power-up mode, this shall be stated as either "user defined" or "not applicable"(n / a). IEC 61157 4.2.2l)	B-mode freeze	
14	AIF	Acoustic initialization fraction. IEC 61157 4.2.2m)	100%	
15	Initialization mode	If appropriate. in systems in which the user defined the initialization mode, this shall be stated as either "user defined" or "not applicable"(n / a). IEC 61157 4.2.2n)	B-mode	
16	Acoustic output freeze	If the system has acoustic output freeze then this shall be stated as "yes", otherwise it shall be stated as "no". IEC 61157 4.2.2o)	Yes	

Test Mode: B-mode
Transducer Type: L1-3

No	Test Item	Requirements and Clauses	Results	Remarks
1	Maximum power (mW)	Maximum temporal-average power output. IEC 61157 4.2.2a)	26.4	Test frequency: 7.5 MHz
2	P ₋ (MPa)	Peak-negative acoustic pressure. IEC 61157 4.2.2b)	2.63	
3	I _{ob} (mW/cm ²)	Output beam intensity. IEC 61157 4.2.2c)	17.86	
4	I _{spta} (mW/cm ²)	Spatial-peak temporal average derived intensity. IEC 61157 4.2.2d)	11.81	
5	System settings	Ultrasound instrument console settings. IEC 61157 4.2.2e)	Focus number:1 Power:80% Frame rate:58	
6	L _p (mm)	Distance from the transducer output face to the point of maximum pulse-pressure-squared integral. IEC 61157 4.2.2f)	21	
7	W _{pb6} (mm)	-6dB pulse-width. IEC 61157 4.2.2g)	(□): 0.78 (□): 2.57	
8	p _{rr} (kHz)	Pulse repetition rate. IEC 61157 4.2.2h)	Not applicable	
9	s _{rr} (Hz)	Scan repetition rate. IEC 61157 4.2.2h)	55.24	
10	Output beam dimensions (cm ²)	Dimensions parallel(∥)and perpendicular(⊥)to the reference direction shall be specified. For scanning modes, these shall refer to the central scan line only. In many cases, especially contact systems, these dimensions may be taken as the geometrical dimensions of the ultrasonic transducer or ultrasonic transducer element group. IEC 61157 4.2.2i)	1.478	
11	f _{awf} (MHz)	Arithmetic-mean acoustic-working frequency. IEC 61157 4.2.2j)	5.20	
12	APF	Acoustic power-up fraction. IEC 61157 4.2.2k)	0%	
13	Power-up mode	In system in which the user defines the power-up mode, this shall be stated as either "user defined" or "not applicable"(n / a). IEC 61157 4.2.2l)	B-mode freeze	
14	AIF	Acoustic initialization fraction. IEC 61157 4.2.2m)	100%	
15	Initialization mode	If appropriate. in systems in which the user defined the initialization mode, this shall be stated as either "user defined" or "not applicable"(n / a). IEC 61157 4.2.2n)	B-mode	
16	Acoustic output freeze	If the system has acoustic output freeze then this shall be stated as "yes", otherwise it shall be stated as "no". IEC 61157 4.2.2o)	Yes	

Test Mode: B/M-mode
Transducer Type: L1-3

No	Test Item	Requirements and Clauses	Results	Remarks
1	Maximum power (mW)	Maximum temporal-average power output. IEC 61157 4.2.2a)	27.6	Test frequency: 7.5 MHz
2	P ₋ (MPa)	Peak-negative acoustic pressure. IEC 61157 4.2.2b)	2.63	
3	I _{ob} (mW/cm ²)	Output beam intensity. IEC 61157 4.2.2c)	18.67	
4	I _{spta} (mW/cm ²)	Spatial-peak temporal average derived intensity. IEC 61157 4.2.2d)	29.60	
5	System settings	Ultrasound instrument console settings. IEC 61157 4.2.2e)	Focus number:1 Power:80% Frame rate:58 ST:1.00s	
6	L _p (mm)	Distance form the transducer output face to the point of maximum pulse-pressure-squared integral. IEC 61157 4.2.2f)	21	
7	W _{pb6} (mm)	-6dB pulse-width. IEC 61157 4.2.2g)	(□): 0.98 (□): 4.10	
8	p _{rr} (kHz)	Pulse repetition rate. IEC 61157 4.2.2h)	0.232	
9	s _{rr} (Hz)	Scan repetition rate. IEC 61157 4.2.2h)	55.55	
10	Output beam dimensions (cm ²)	Dimensions parallel(∥)and perpendicular(⊥)to the reference direction shall be specified. For scanning modes, these shall refer to the central scan line only. In many cases, especially contact systems, these dimensions may be taken as the geometrical dimensions of the ultrasonic transducer or ultrasonic transducer element group. IEC 61157 4.2.2i)	1.478	
11	f _{awf} (MHz)	Arithmetic-mean acoustic-working frequency. IEC 61157 4.2.2j)	5.20	
12	APF	Acoustic power-up fraction. IEC 61157 4.2.2k)	0%	
13	Power-up mode	In system in which the user defines the power-up mode, this shall be stated as either "user defined" or "not applicable"(n / a). IEC 61157 4.2.2l)	B-mode freeze	
14	AIF	Acoustic initialization fraction. IEC 61157 4.2.2m)	100%	
15	Initialization mode	If appropriate. in systems in which the user defined the initialization mode, this shall be stated as either "user defined" or "not applicable"(n / a). IEC 61157 4.2.2n)	B-mode	
16	Acoustic output freeze	If the system has acoustic output freeze then this shall be stated as "yes", otherwise it shall be stated as "no". IEC 61157 4.2.2o)	Yes	

Appendix C Obstetric table

Gestational Table 1: Equine

Measurement (mm) (Gestational Sac Diameter)	Week	Day
6	1	4
8	1	4
10	1	5
12	1	6
14	1	6
16	2	0
18	2	0
20	2	1
22	2	2
24	2	3
26	2	5
28	4	1
30	4	2
32	4	3
34	4	4
40	5	0
42	5	2
44	5	3
46	5	4
48	5	5
50	5	6
52	6	1
54	6	2
56	6	3

All measurements +/- 3 days

Gestational Table 2: Bovine

Measurement (mm)	Week	Day
(Body Length)		
8	4	0
10	5	0
12	5	1
14	5	2
16	5	3
18	5	5
20	5	5
22	5	6
24	5	6
26	6	1
28	6	1
30	6	1
32	6	2
34	6	3
36	6	3

All measurements +/- 3 days

Gestational Table 3: Sheep

Measurement (mm) (Umbilicus to Spine)	Week	Day
15	7	1
18	7	3
21	7	6
24	8	1
27	8	4
30	9	0
33	9	2
36	9	4
39	10	0
42	10	2
45	10	5
48	11	3
51	11	5
54	12	1
57	12	2
60	12	4
63	12	6
66	13	2
69	13	4
72	14	2
75	14	4
78	15	0
81	15	2
84	15	5
87	16	6
90	17	0
93	17	1
96	17	3
99	17	6

All measurements +/- 3 days